

Drilling tool holder D14

Technical data

| | |
|----------------------|---|
| Drive | not live |
| Fixation MS | Clamping ring D28.5 |
| Cooling | internal |
| Pressure | 80 bar |
| Mounting | D14 |
| X [mm] | - |
| Y [mm] | - |
| Z [mm] | - |
| INDEX TRAUB products | A100 • MS16-6 • MS22-6 • MS22-8 • MS24-6 • MS16-6 Plus |

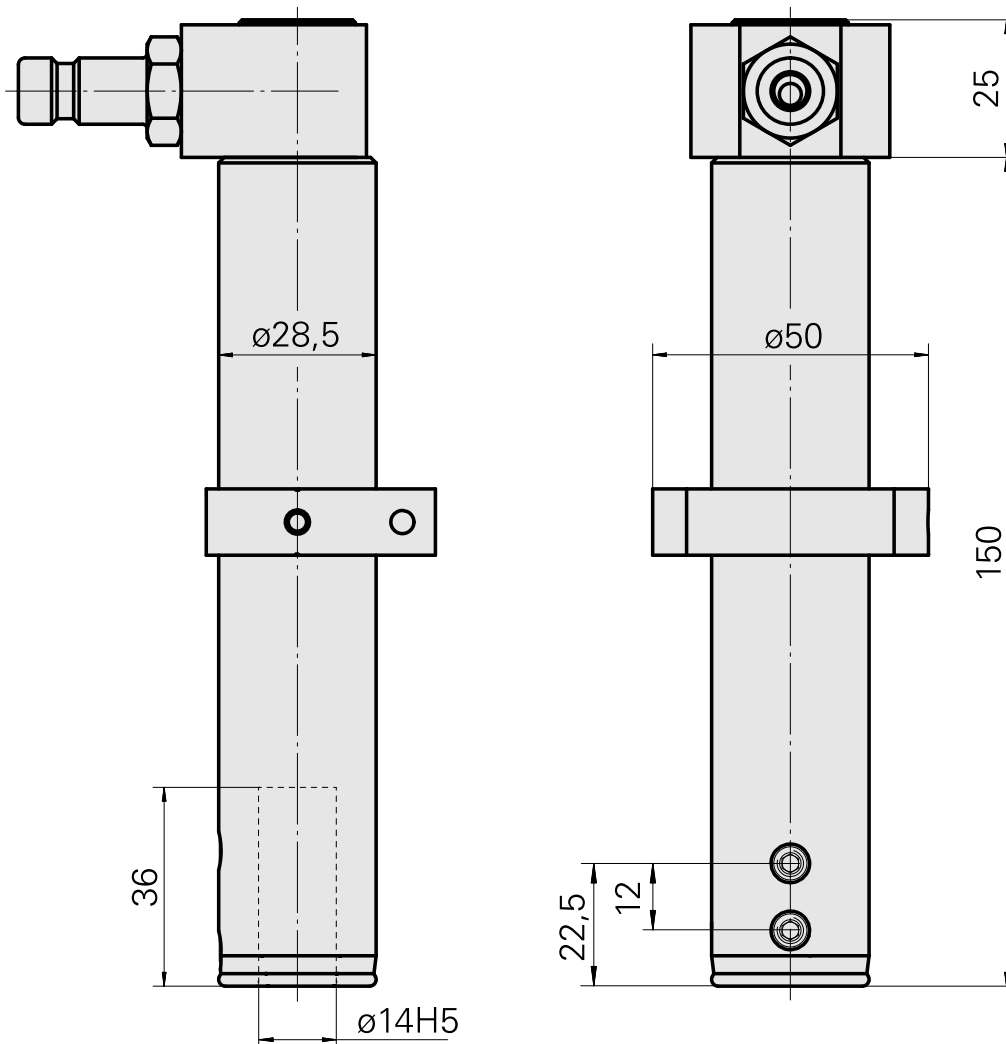

Documents

No downloads available for this product

Accessories

Optional accessories

Other accessories

[QUICK COUPLING SP-006-0-WR513-11-2 Serie LP](#)

Product ID : 10837142

Previous product ID : 474940.0112

[QUICK DISCONNECT FITTING SP-006-1-WR013-11 Serie LP](#)

Product ID : 10186287

Previous product ID : 474946.25
