

Porte-foret HSK 40 A DIN 1835 B/E D10

Données techniques

Queue HSK	HSK 40
Forme HSK	A
Attachement	DIN 1835 B/E D10
Arrosage	central
Pression	80 bar
X [mm]	45,5
Produits INDEX TRAUB	G160 • V100 • G200.2 • R200 • TNX65/42 • G220.3 • TNX220.3

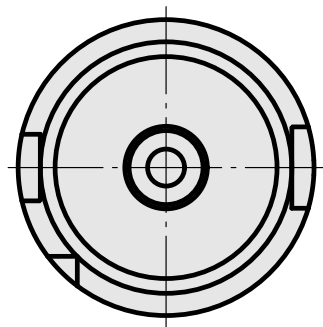
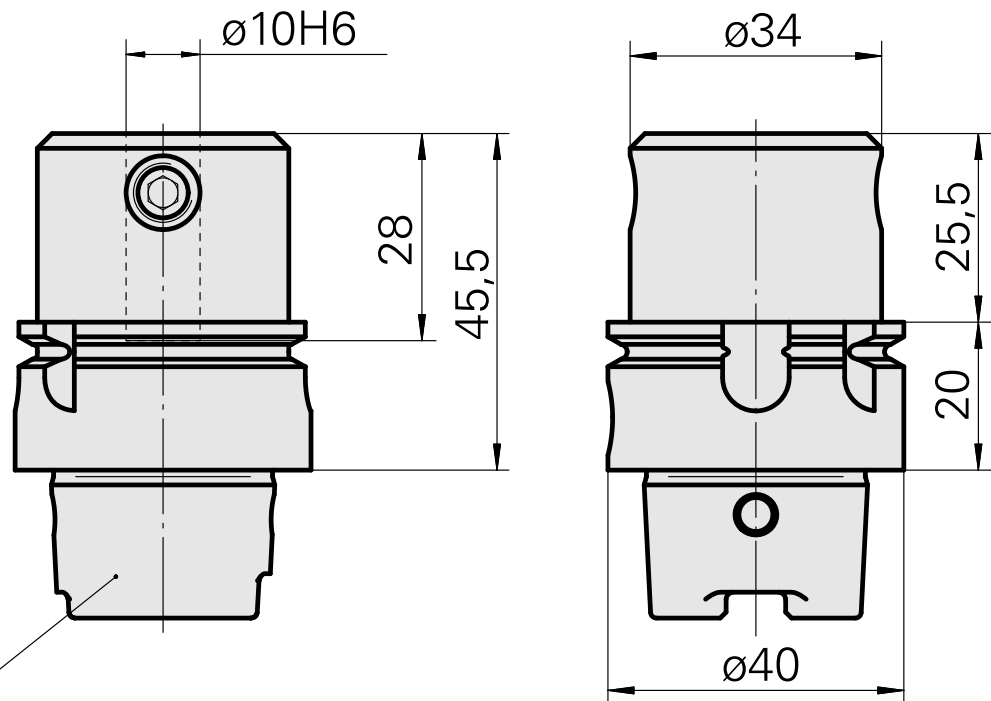

Documents

Aucun téléchargement n'est disponible pour ce produit

Accessoires

Nécessaire à l'exploitation

Clé à douille

ID produit : 10532354

Ancienne ID produit : WS7400.0010

Catégorie d'accessoires PO Outil pour adaptateur KSS	Attachement HSK 40 A/C
---	---------------------------

Accessoires optionnels

Accessoires de porte-outils

Kit d'adaptateur de lubrifiant

ID produit : 10581780

Ancienne ID produit : WS7400.0020

Catégorie d'accessoires PO Jeu de transmission lubrifiant	Attachement HSK 40 A/C
--	---------------------------

Amenée lubrifiant, maximum 120 bar

ID produit : 12024083

Ancienne ID produit :

Catégorie d'accessoires PO Jeu de transmission lubrifiant	Attachement HSK 40 A/C
--	---------------------------