

## Drilling tool holder VDI 30 D16, Form E2

### Technical data

<b>Shank VDI</b>	VDI 30
<b>Drive</b>	not live
<b>Fixation VDI</b>	none
<b>Cooling</b>	external and internal
<b>Pressure</b>	20 bar
<b>Mounting</b>	D16
<b>reversible 180°</b>	no
<b>Data carrier</b>	check tool station bore
<b>X [mm]</b>	60 (2.36")
<b>Y [mm]</b>	-
<b>Z [mm]</b>	-
<b>INDEX TRAUB products</b>	V100 • V200 • V160C • V160G • V300 • TNA300

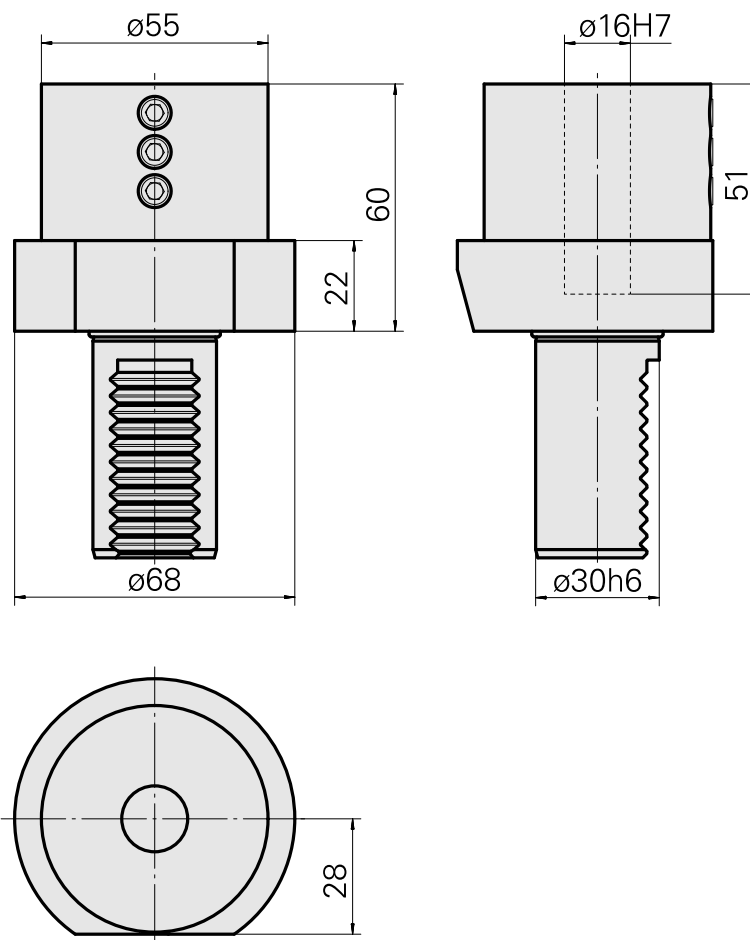
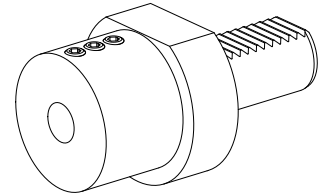

## **Documents**

No downloads available for this product

## **Accessories**

Optional accessories

### **Other accessories**

[Mounting sleeve with collar D16](#)

Product ID : 10914323

Previous product ID : W67511.04--

---