

## WFB 32-20 Shrink-fit mounting D12

### Technical data

TH accessories category

WFB 32-20

Mounting

Shrink-fit mounting D12

Quick change inserts

shrink-fit mounting

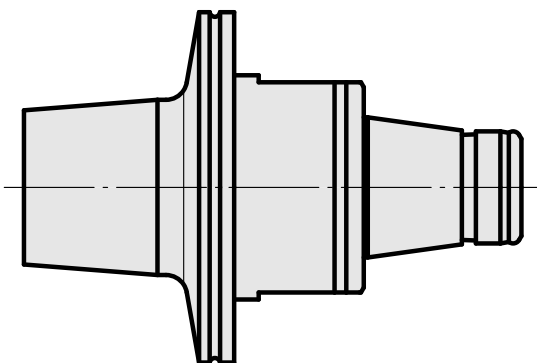
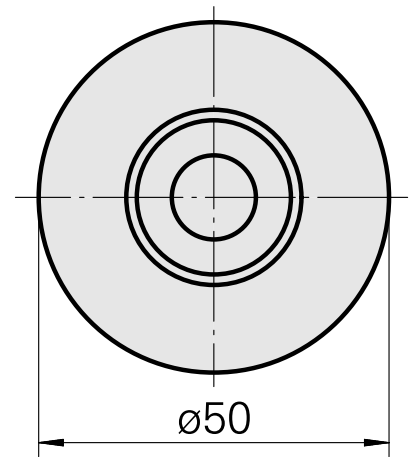
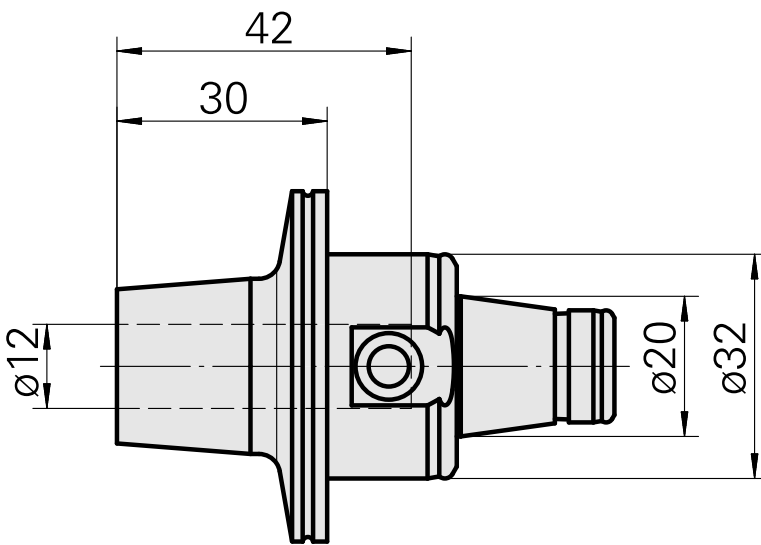
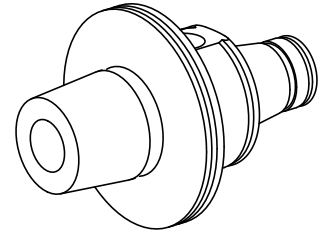

10276872  
836266

**INDEX**

---

## **Documents**

No downloads available for this product