

WFB 32-20 Horn Type B114, left

Caratteristiche tecniche

Categoria acces. portautensile	WFB 32-20
Attacco	Horn Type B114, left
Accessorio per cambio rapido	Horn S-Mini

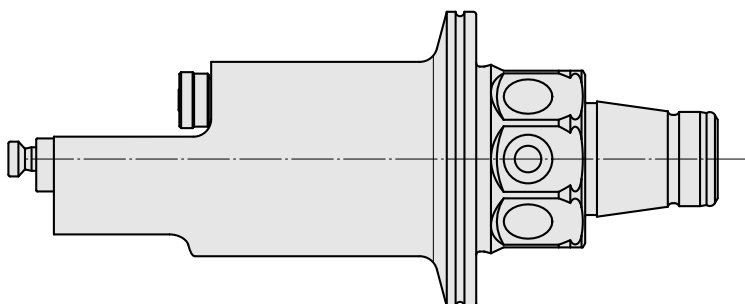
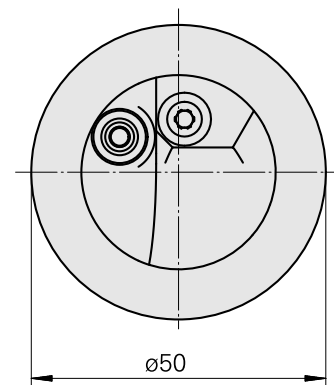
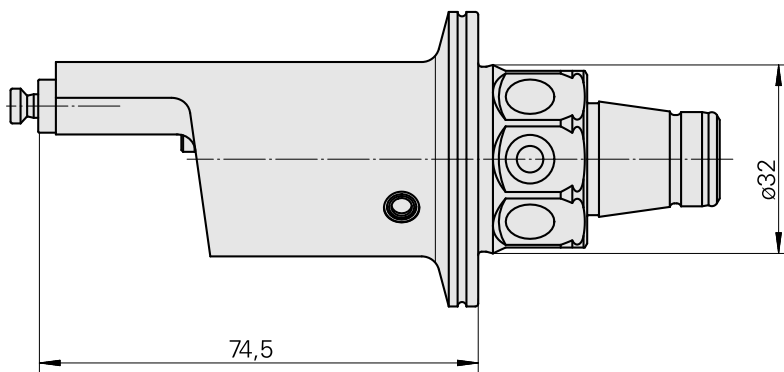
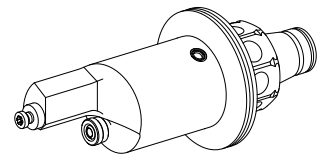

Documenti

Non sono disponibili download per questo prodotto