

Adattatore

Caratteristiche tecniche

Categoria acces. portautensile

Adattatore disp. preregolaz.

Attacco

D80 per preimpostazione

Attacco per utensile

HSK 63

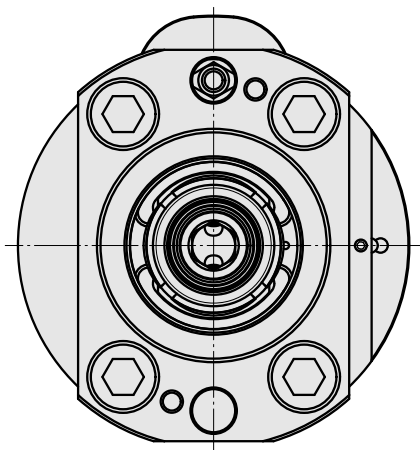
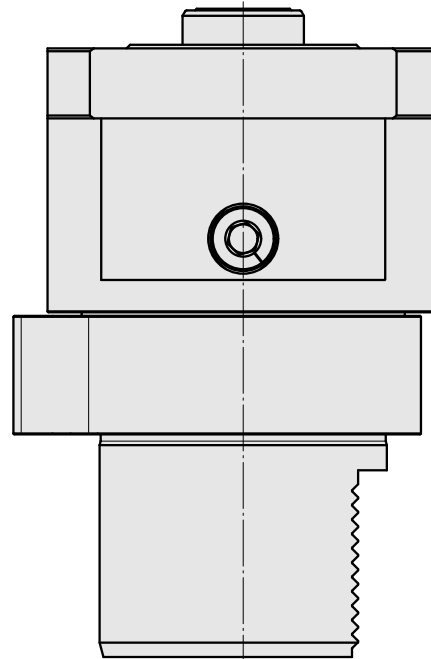
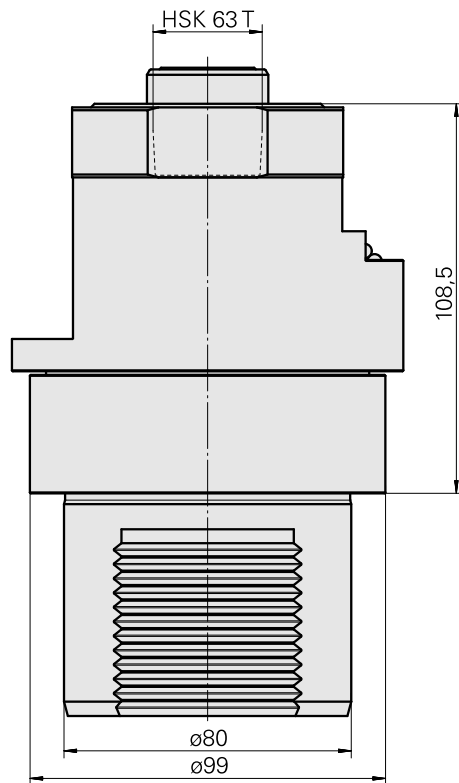
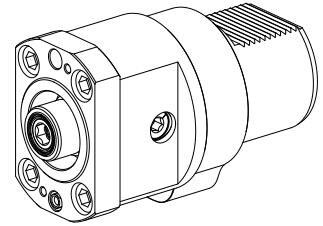

Documenti

Non sono disponibili download per questo prodotto