

## WFB 32-20 D6

### Technical data

TH accessories category	WFB 32-20
Mounting	D6
Quick change inserts	Weldon mounting

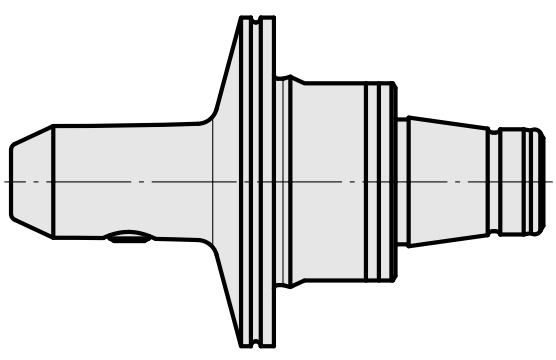
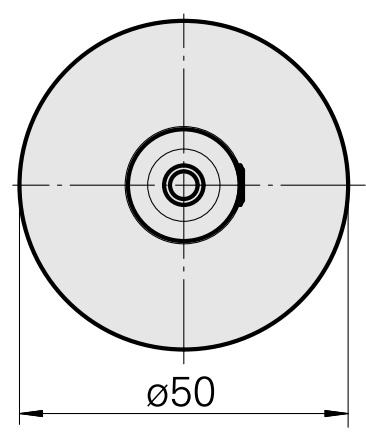
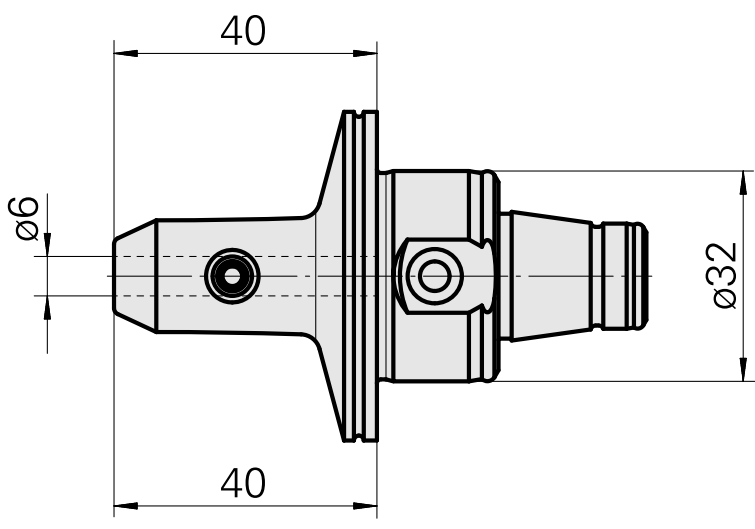
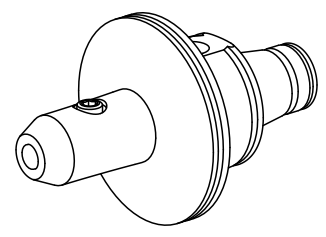

10032534  
W9990794

**INDEX**

---

## **Documents**

No downloads available for this product