

Guide bush T223 Ø=12,00

Technical features

Clamping device size	T223 deadlength
Ext. manufacturer product line	
Clamping type	with carbide insert
Nominal diameter (mm)	12 Millimeter
Clamping method	External clamping
Collet design	programmable (Axfix)
Collet version	S-slot
Ext. manufacturer product line	Schlenker

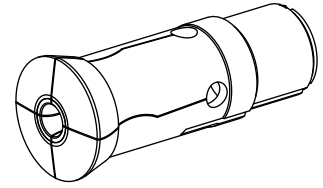

Note

with bushing

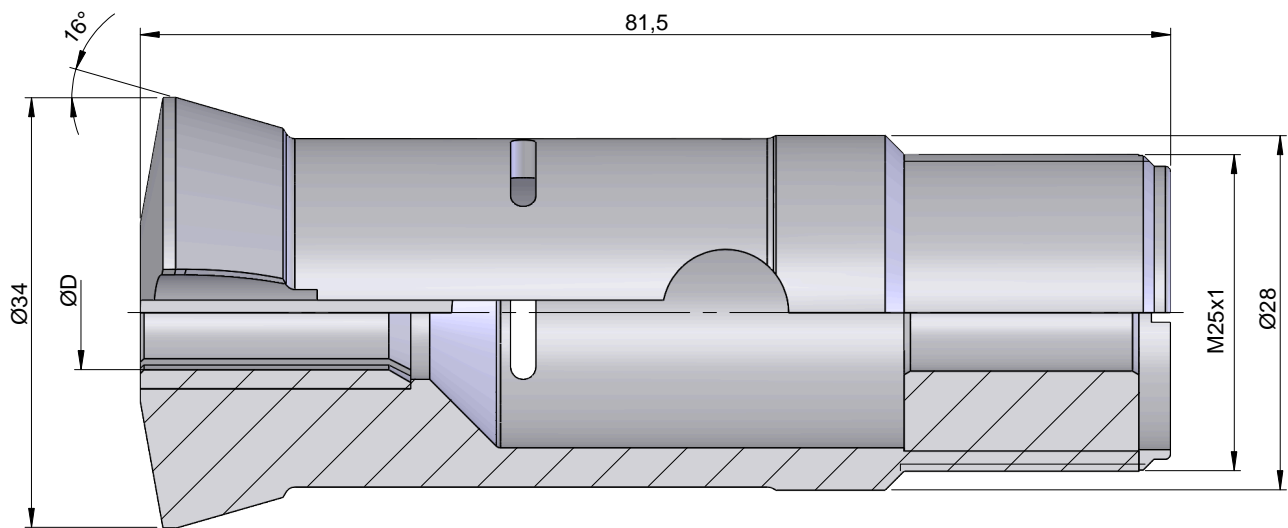

Documents

No downloads available for this product