

## Guide bush T223 Ø=7,00

### Technical data

Clamping device size manufacturer product line	T223 deadlength
Clamping type	with carbide insert
Nominal diameter (mm)	7 Millimeter
Clamping method	External clamping
Collet design	programmable (Axfix)
Collet version manufacturer product line	S-slot Schlenker

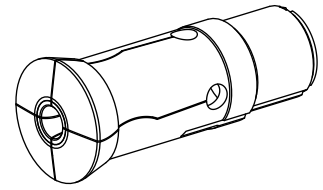

### Note

with bushing

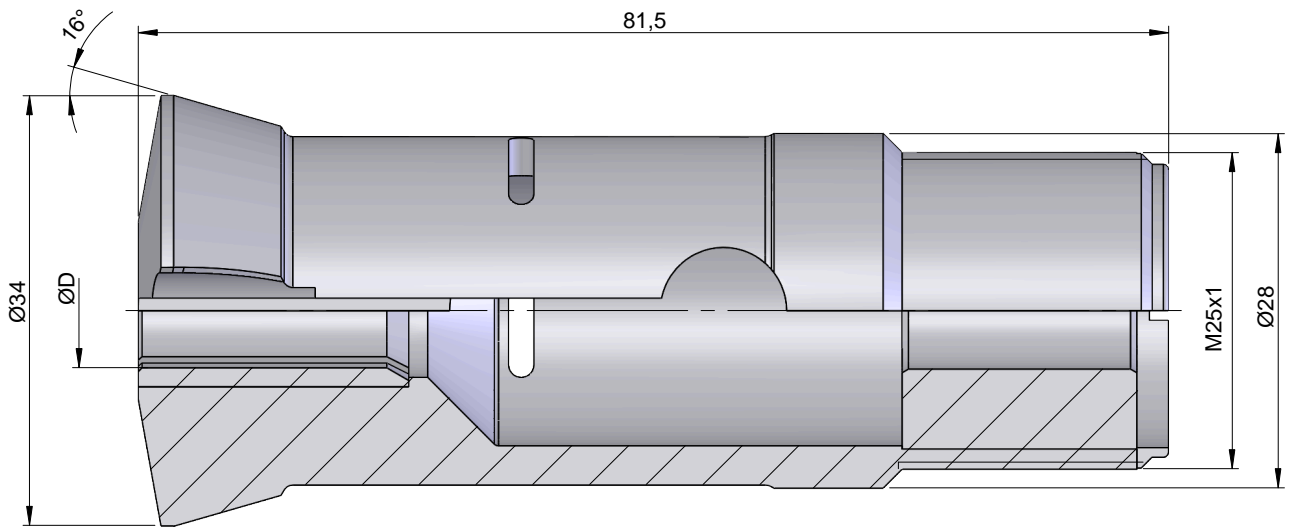

## **Documents**

No downloads available for this product