

Drilling tool holder Hydraulic expansion

Technical data

Drive	not live
Fixation MS	Clamping ring D28.5
Cooling	internal
Pressure	80 bar
Mounting	Hydraulic expansion chuck D6
X [mm]	-
Y [mm]	-
Z [mm]	-
INDEX TRAUB products	MS22-6 • MS22-8 • MS16-6 • MS24-6 • MS16-6 Plus

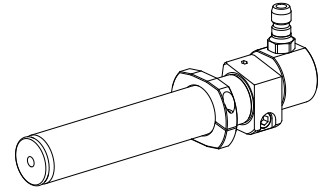

Documents

Product notes

[DE \(pdf\)](#)

[EN \(pdf\)](#)

[FR \(pdf\)](#)

Accessories

Optional accessories

Other accessories

[QUICK COUPLING SP-006-0-WR513-11-2 Serie LP](#)

Product ID : 10837142

Previous product ID : 474940.0112
