

Adapter mounting aid WFB 32-20

Technical data

TH accessories category

Adapter mounting aid

Tool mounting

WFB 32-20

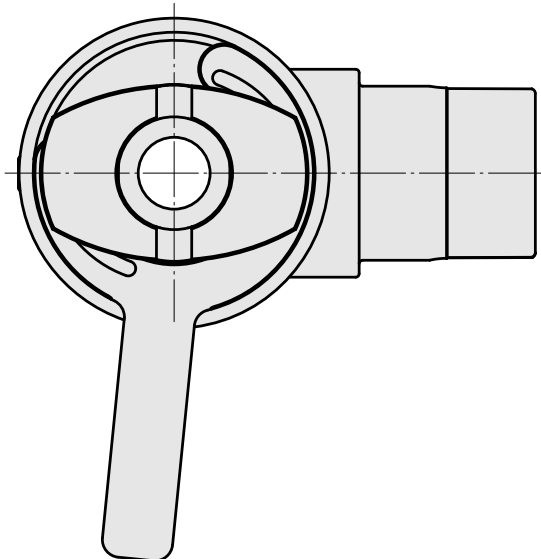
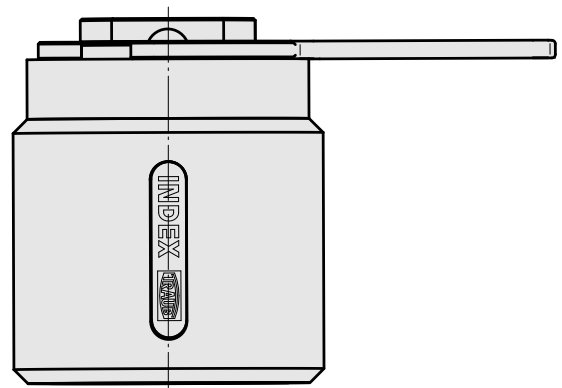
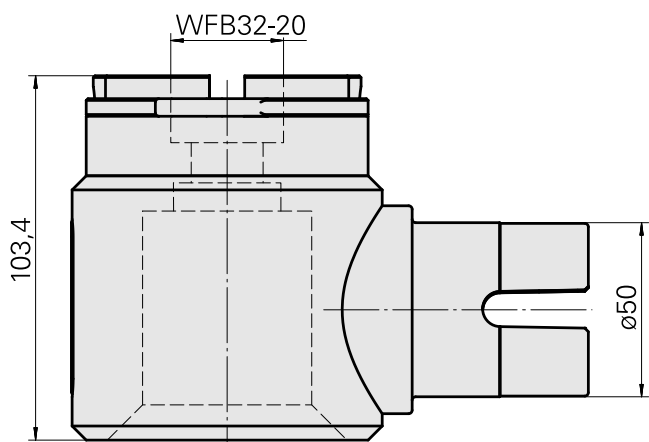
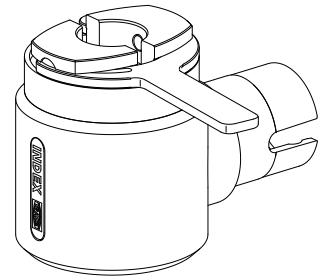

Documents

No downloads available for this product