

Grooving tool holder KPS 45 Trapezoid 32

Technical data

Shank KPS	KPS 45
Drive	not live
Cooling	internal
Mounting	Trapezoid 32x8
Pressure	80 bar
X [mm]	68 (2.68")
Y [mm]	-
Z [mm]	-6 (-0.24)
INDEX TRAUB products	TNL18 • TNL20 • TNL32-11 • TNL32 • TNL32-11 compact • TNL20-11 • TNL32 compact • TNK40.2-10 • TNL20.2 • TNK40.2

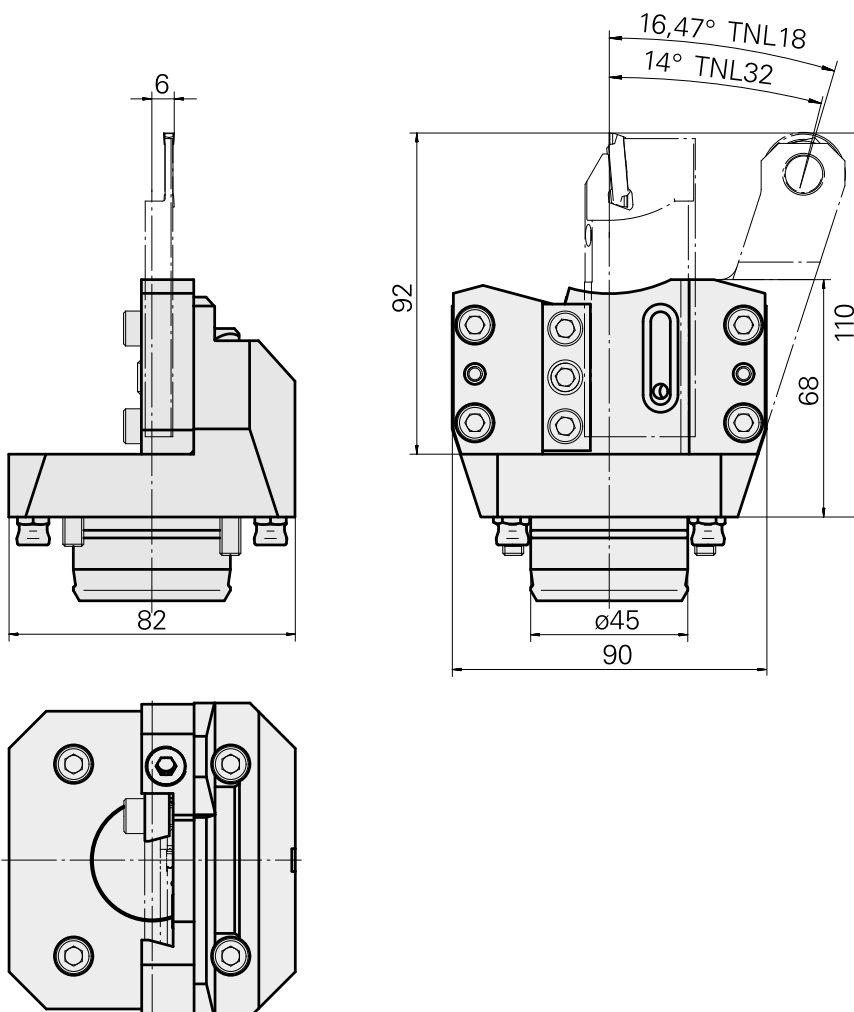
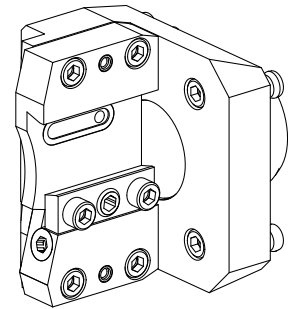

Documents

No downloads available for this product

Accessories

Optional accessories

O-Rings

[Gasket ring OR 18,77X1,78](#)

Product ID : 10897583

Previous product ID : 316038

manufacturer product line Trelleborg	TSS material no.	Cord size 1.78 Millimeter	manufacturer product line O-ring
---	------------------	------------------------------	-------------------------------------

Tool holders with compact shank

[Bar stop, live](#)

Product ID : 10436606

Previous product ID : W9990516

Drive not live	INDEX TRAUB products TNL32-11 compact • TNL32 • TNL20-11 • TNL32 compact • TNK40.2-10 • TNL20 • TNL32-10 • TNL32-11 • TNL32-7 • TNL32-7B • TNL32-8 • TNL32-9 • TNL32-9P • TNL32P • TNL20.2 • TNK40.2
-------------------	---

Other accessories

[Bush 4x8x12](#)

Product ID : 10831938

Previous product ID : W02010.0002

[Hollow screw M12x1](#)

Product ID : 10757766

Previous product ID : W02013.0001

10958857
W7040097

INDEX

Nozzle Kugel-D8

Product ID : 10007891
Previous product ID : 904837

Locking screw M12x1

Product ID : 10135400
Previous product ID : 910677
