

## Bohrhalter Schaft 40 D14

### Technische Daten

Schaft TNL	Schaft 40
Antrieb	nicht angetrieben
Kühlung	innen
Druck	120 bar
Aufnahme	D14
Produkte INDEX TRAUB	TNK36 • TNL26

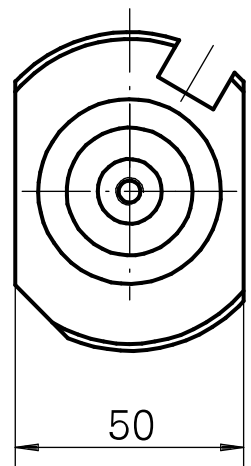
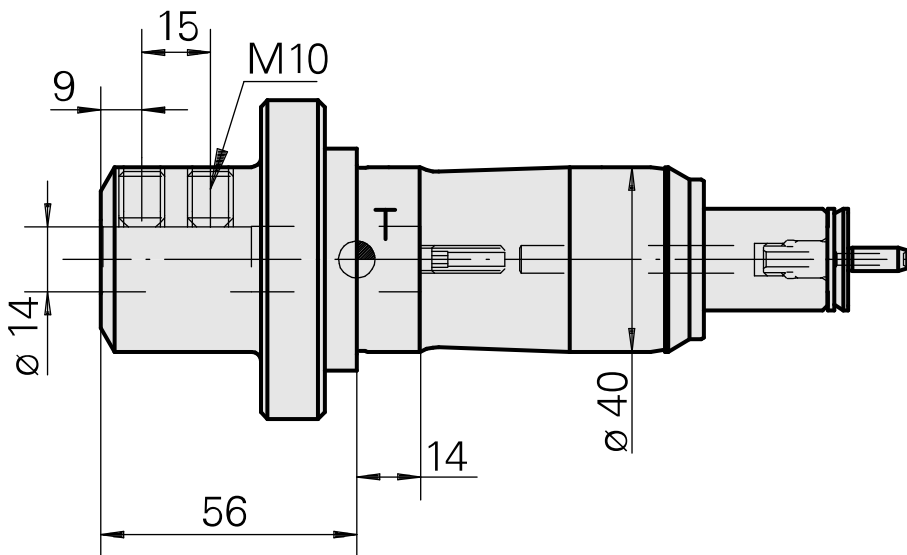
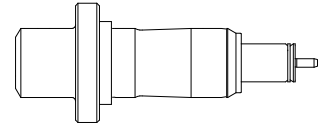

## **Dokumente**

Für dieses Produkt sind keine Downloads vorhanden