

WFB 32-20 D10

Technical data

TH accessories category	WFB 32-20
Mounting	D10
Quick change inserts	Weldon mounting

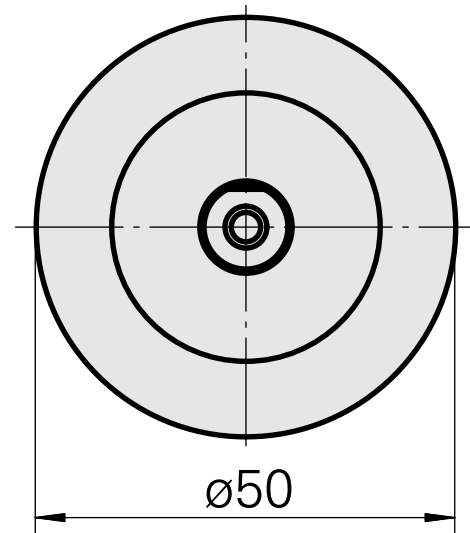
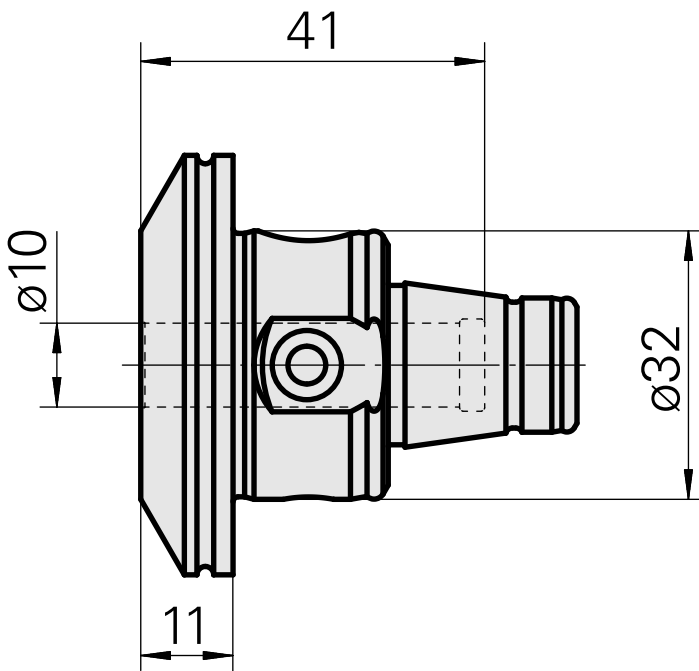

Documents

No downloads available for this product