

WFB 20-12 for CC.. 09T3.., right, without gripper groove

Technical data

TH accessories category

WFB 20-12

Mounting

for CC.. 09T3..

Quick change inserts

Turning tool holder

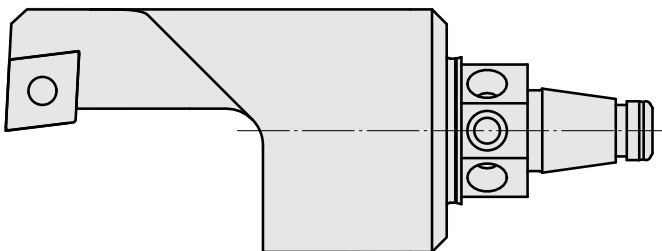
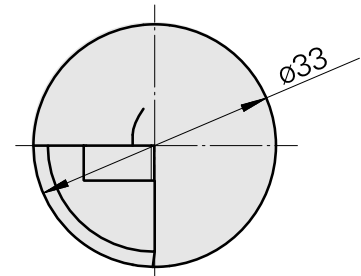
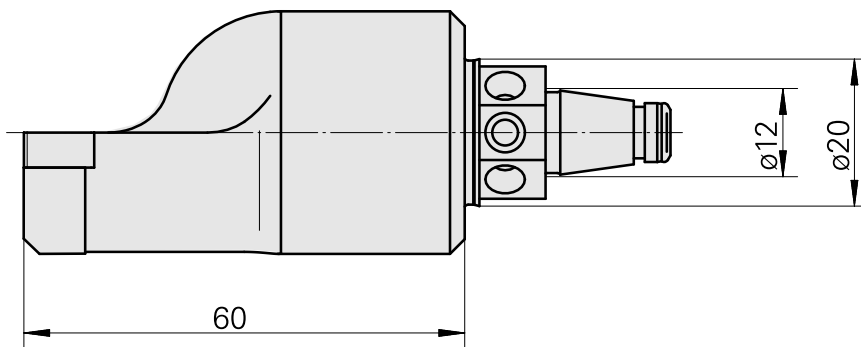
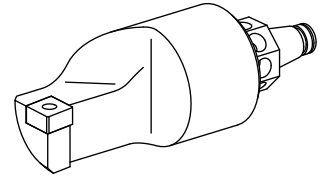

10530834
W9990231

INDEX

Documents

No downloads available for this product