

## WFB 32-20 D20

### Technical data

TH accessories category	WFB 32-20
Mounting	D20
Quick change inserts	Weldon mounting

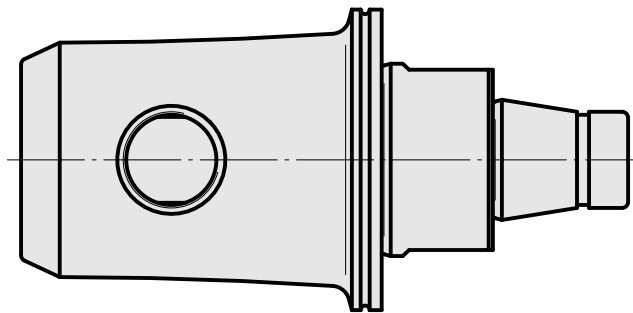
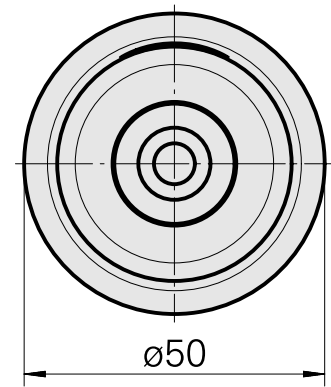
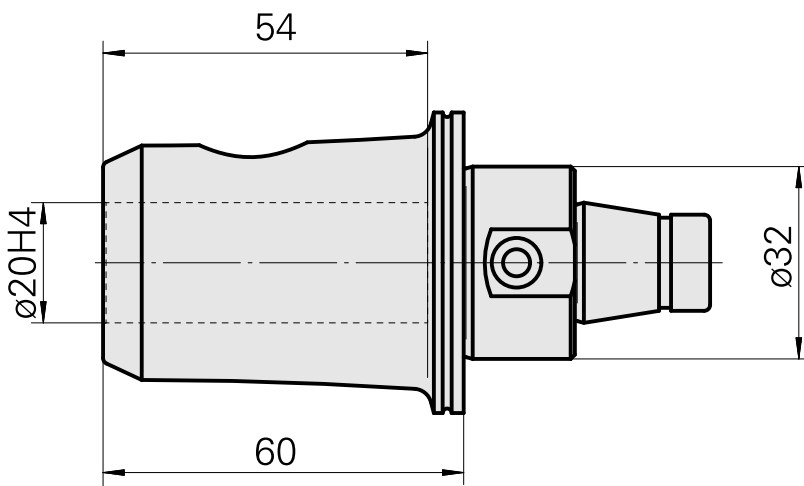
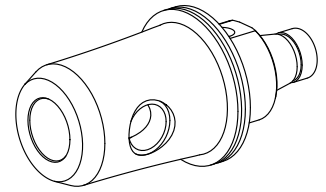

## **Documents**

No downloads available for this product

## **Accessories**

Optional accessories

### **Other accessories**

[Mounting sleeve with collar D20](#)

Product ID : 10063939

Previous product ID : W68510.04--

---