

WFB 32-20 Fräswelle D27

Technische Daten

WZH Zubehörkategorie

WFB 32-20

Aufnahme

Fräswelle D27

Schnellwechseleinsätze

Fräsdornaufnahme

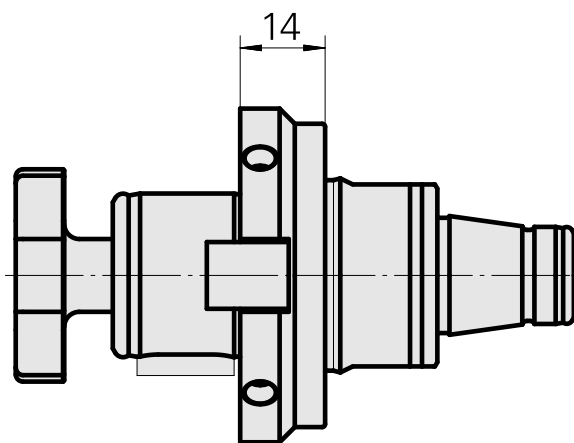
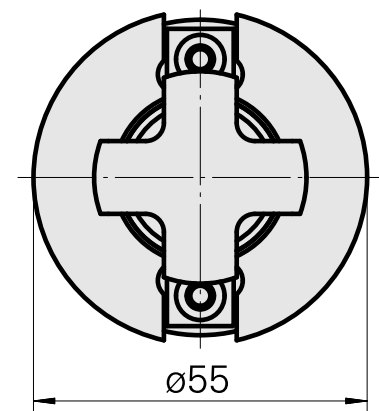
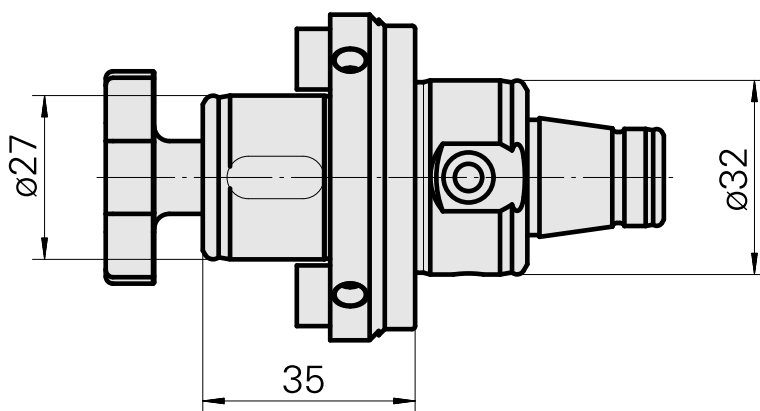
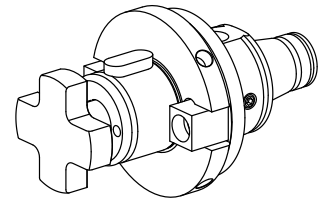

Dokumente

Für dieses Produkt sind keine Downloads vorhanden

Zubehör

Zum Betrieb benötigt

Fräsdornschlüssel 27

Artikel-Id : 10860744
frühere Artikel-Id : 203020.1270

WZH Zubehörkategorie Werkzeug für Spannzangen	Aufnahme Fräswelle D27	Werkzeug für Spannzangen Fräsdornschlüssel
---	---------------------------	--

Optionales Zubehör

Zubehör für Werkzeughalter

Fräseranzugsschraube M12

Artikel-Id : 10085152
frühere Artikel-Id : 250122.1235

WZH Zubehörkategorie Fräseranzugsschraube	Aufnahme M12
--	-----------------

weiteres Zubehör

Ringe

Artikel-Id : 10398855
frühere Artikel-Id : 251390.----

FRÄSDORNRING

Artikel-Id : 10169490
frühere Artikel-Id : 251391.----
