

WFB 32-20 液压膨胀刀柄 D8

技术特点

刀座附件类别
夹具
快换夹头

WFB 32-20
液压膨胀刀柄 D8
带液压膨胀刀柄

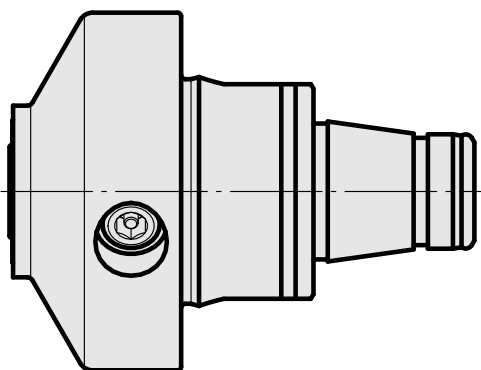
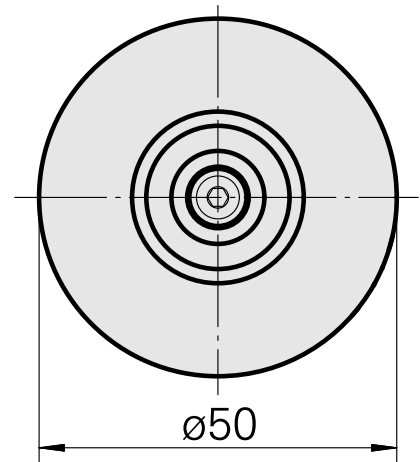
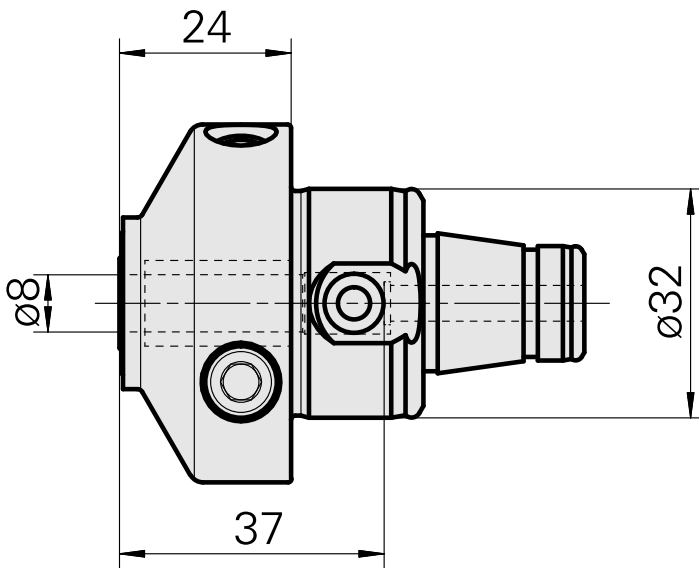
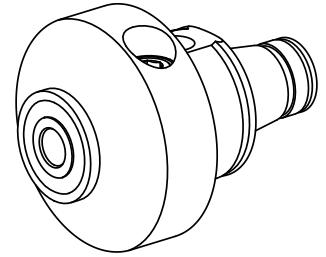

文件

产品提示

[DE \(pdf\)](#)

[EN \(pdf\)](#)

[FR \(pdf\)](#)