

ER-Collet chuck for taps ET 1-25 8mm

Technical data

TH accessories category	ER-Collet chuck for taps
Mounting	ER25
Tool mounting	8mm
Collet type	ET 1-25

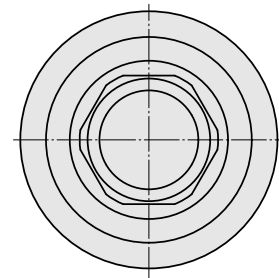
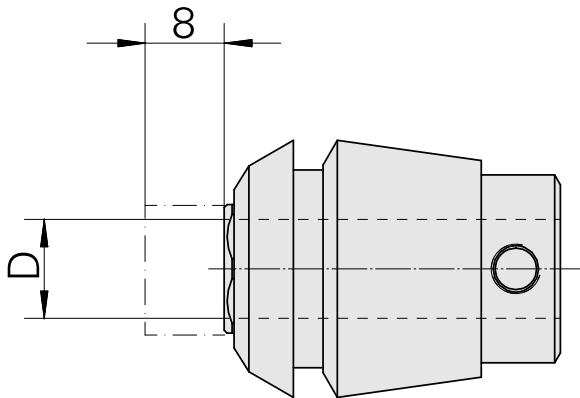
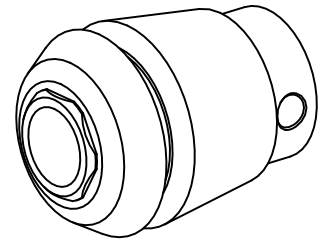

10072784
322458

INDEX

Documents

No downloads available for this product