

## Guide bush T223 Ø=10,00

### Technical data

|   |                             |
|---|-----------------------------|
| Clamping device size<br>manufacturer product line | T223 deadlength             |
| Clamping type                                     | with carbide insert         |
| Nominal diameter (mm)                             | 10 Millimeter               |
| Clamping method                                   | External clamping           |
| Collet design                                     | programmable (Axfix)        |
| Collet version                                    | Slots vulcanized (standard) |
| manufacturer product line                         | Schlenker                   |

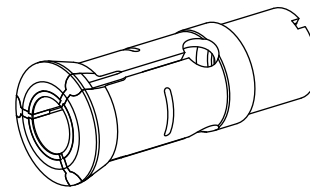

### Note

with bushing

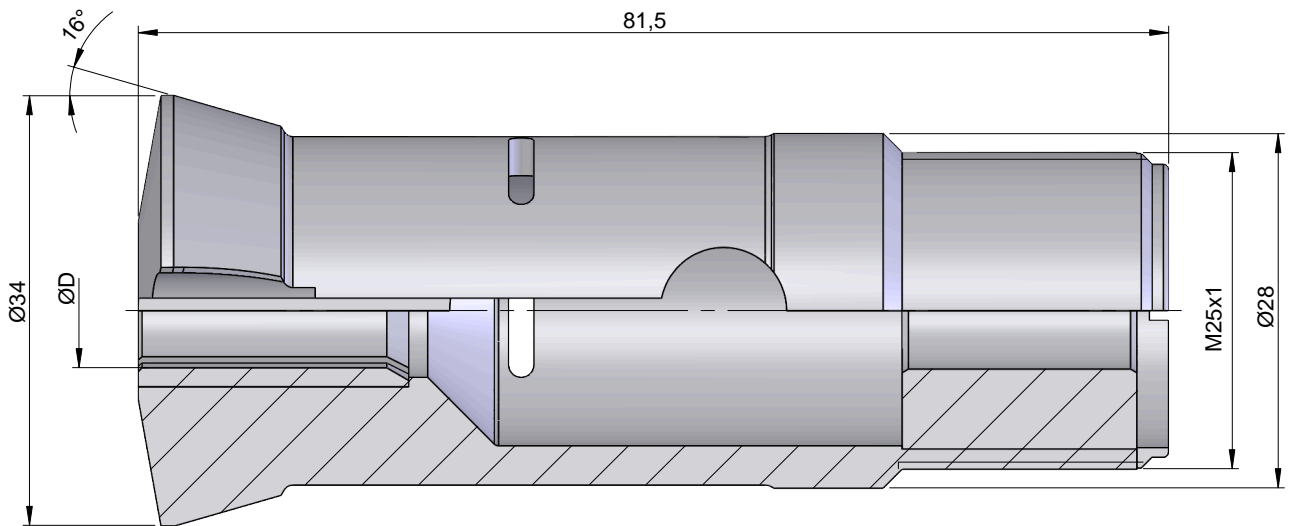

## **Documents**

No downloads available for this product