

## Milling unit Circular prism 2:1 WFB 32-2

### Technical data

Shank TNL	Circular prism
Drive	Overall drive
Fixation TNL	Central tensioning screw
Speed ratio	2:1
Cooling	external
Pressure	30 bar
Mounting	WFB 32-20
INDEX TRAUB products	TNK36 • TNL26

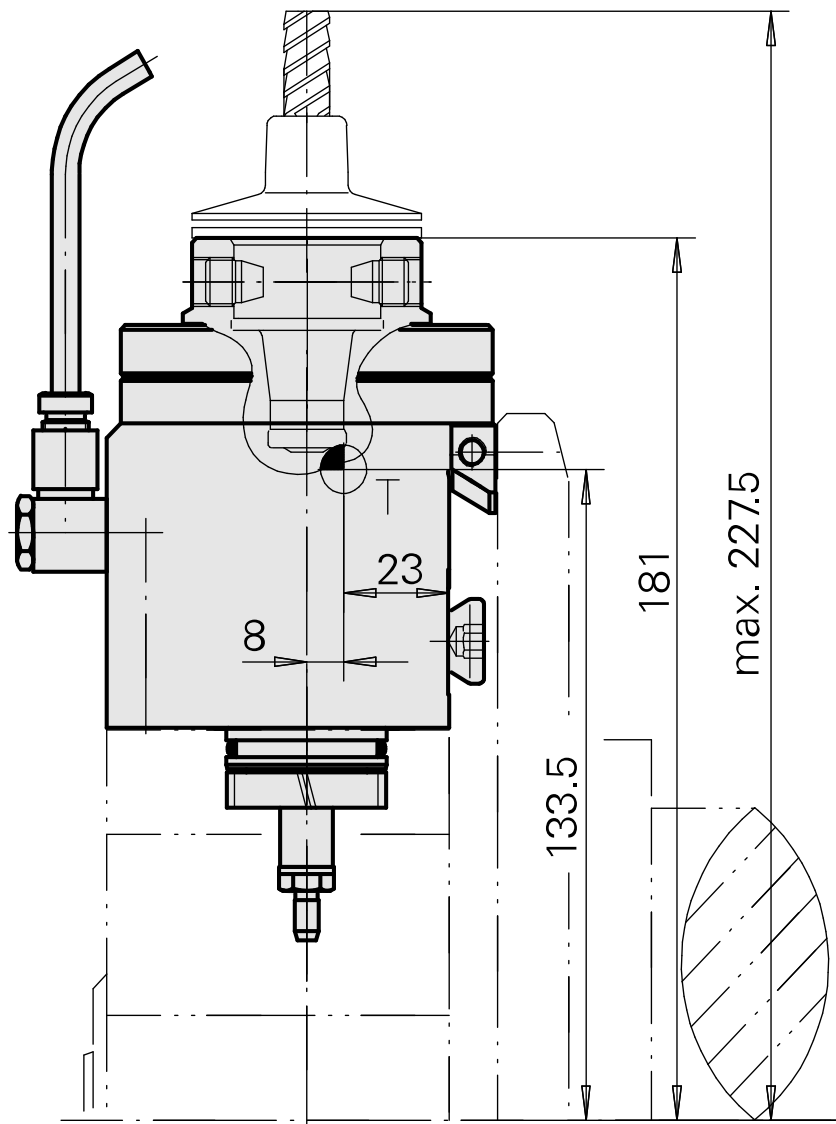
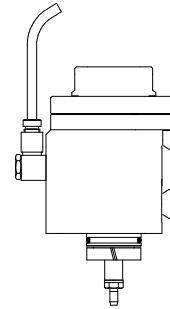

## Documents

### Product notes

[DE \(pdf\)](#)

[EN \(pdf\)](#)

[FR \(pdf\)](#)

[PT \(pdf\)](#)

## Accessories

### Optional accessories

#### Other accessories

#### [Multiple swivel joint M10X1/M10X1/VOG / 506-140](#)

Product ID : 10829996

Previous product ID : 314431

---

#### [Conical ring 6D](#)

Product ID : 10057204

Previous product ID : 314739

---

#### [Cap screw 406-612](#)

Product ID : 10067675

Previous product ID : 314740

---

#### [Tube 100LG](#)

Product ID : 10929574

Previous product ID : 818617

---

#### [Shrink WFB 32-20 adapter](#)

Product ID : 10726868

Previous product ID : WZ9990.3206F

---

---

[Adapter WFB 32-20 Weldon](#)

Product ID : 10305353  
Previous product ID : WZ9990.3207F

---

[Adapter WFB 32-20 with collet mounting](#)

Product ID : 10298507  
Previous product ID : WZ9990.3208F

---

[adapter WFB 32-20 mill arbor mounting](#)

Product ID : 10640736  
Previous product ID : WZ9990.3209F

---

[WFB hydr. expansion mounting](#)

Product ID : 10946690  
Previous product ID : WZ9990.3210F

---

[Adapter WFB 32-20 Horn S-Mini](#)

Product ID : 10546762  
Previous product ID : WZ9990.3211F

---

[adapter WFB 32-20Turning holder](#)

Product ID : 11010003  
Previous product ID : WZ9990.3212F

---

[Grub screw M10x1x11](#)

Product ID : 10165359  
Previous product ID : 326057

---