

Drilling tool holder Shank 40 D16 (0.63)

Technical data

Shank TNL	Shank 40
Drive	not live
Cooling	internal
Pressure	120 bar
Mounting	D16
INDEX TRAUB products	TNK36 • TNL26

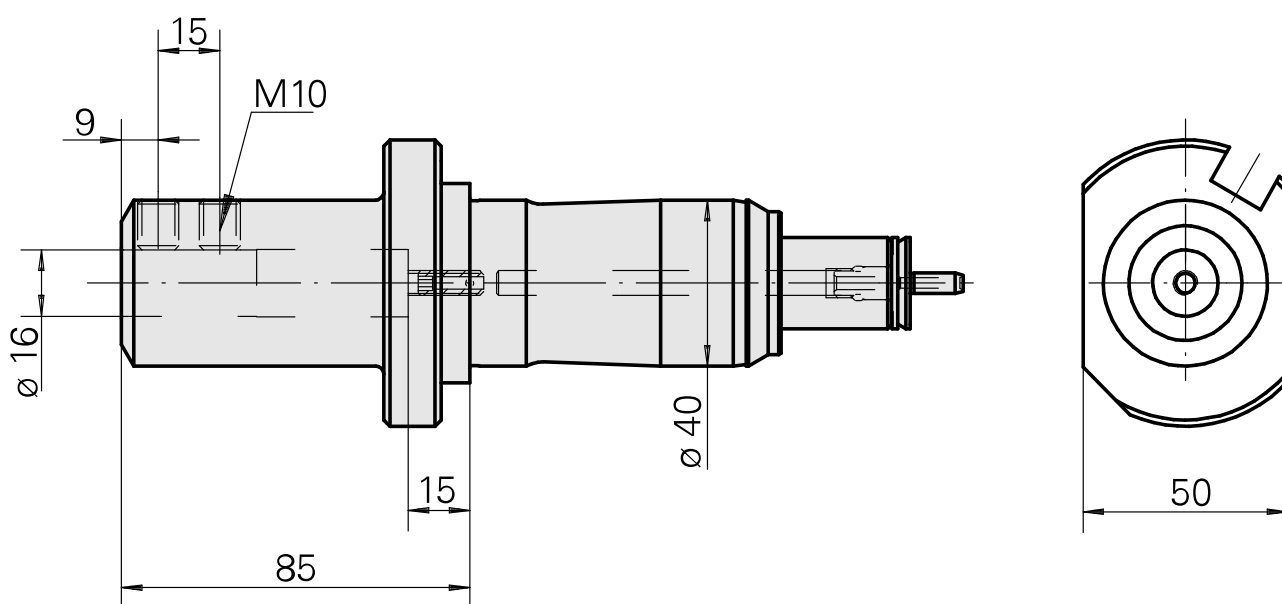
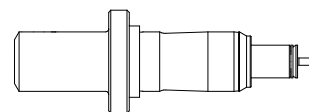

10975903
986942

INDEX

Documents

No downloads available for this product