

Milling unit Circular prism 1:1 WFB 32-2

Technical data

| | |
|----------------------|--------------------------|
| Shank TNL | Circular prism |
| Drive | Overall drive |
| Fixation TNL | Central tensioning screw |
| Speed ratio | 1:1 |
| Cooling | external |
| Pressure | 30 bar |
| Mounting | WFB 32-20 |
| INDEX TRAUB products | TNK36 • TNL26 |

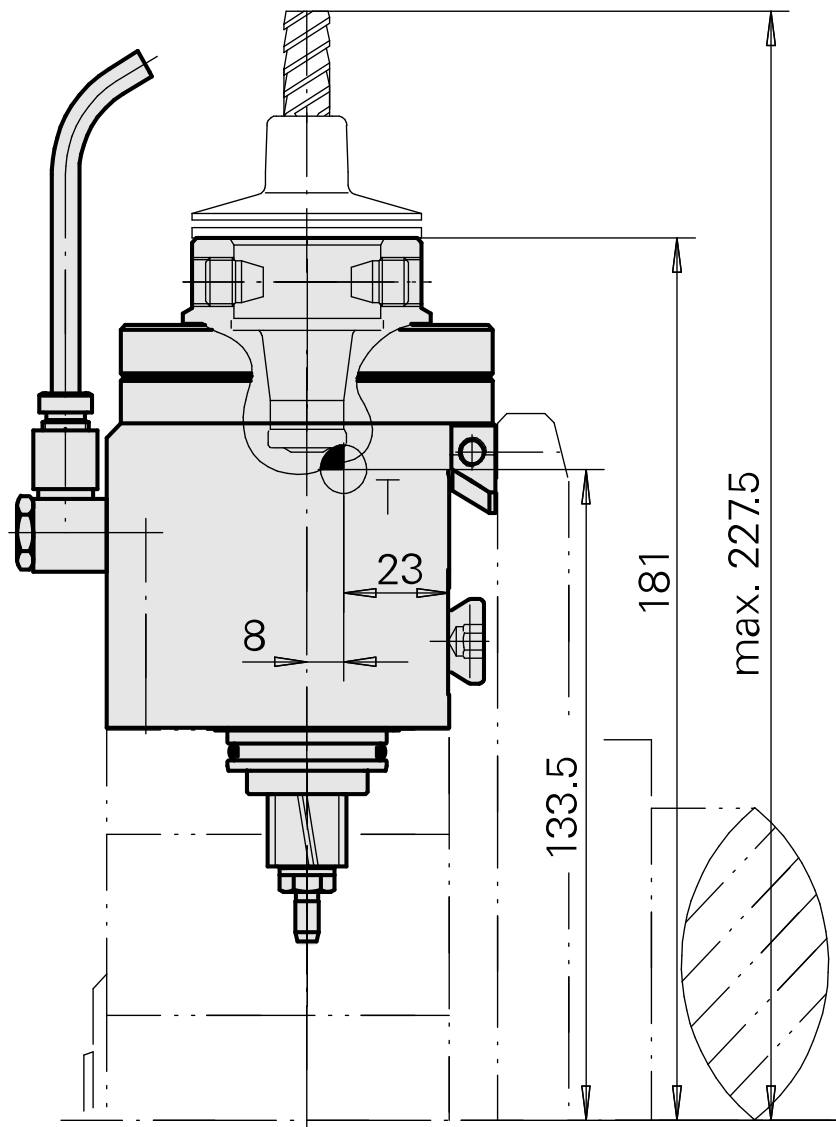
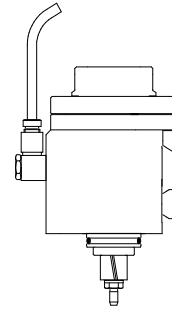

Documents

Product notes

[DE \(pdf\)](#)

[EN \(pdf\)](#)

[FR \(pdf\)](#)

[PT \(pdf\)](#)

Accessories

Optional accessories

Other accessories

[Multiple swivel joint M10X1/M10X1/VOG / 506-140](#)

Product ID : 10829996

Previous product ID : 314431

[Conical ring 6D](#)

Product ID : 10057204

Previous product ID : 314739

[Cap screw 406-612](#)

Product ID : 10067675

Previous product ID : 314740

[Tube 100LG](#)

Product ID : 10929574

Previous product ID : 818617

[Shrink WFB 32-20 adapter](#)

Product ID : 10726868

Previous product ID : WZ9990.3206F

[Adapter WFB 32-20 Weldon](#)

Product ID : 10305353
Previous product ID : WZ9990.3207F

[Adapter WFB 32-20 with collet mounting](#)

Product ID : 10298507
Previous product ID : WZ9990.3208F

[adapter WFB 32-20 mill arbor mounting](#)

Product ID : 10640736
Previous product ID : WZ9990.3209F

[WFB hydr. expansion mounting](#)

Product ID : 10946690
Previous product ID : WZ9990.3210F

[Adapter WFB 32-20 Horn S-Mini](#)

Product ID : 10546762
Previous product ID : WZ9990.3211F

[adapter WFB 32-20Turning holder](#)

Product ID : 11010003
Previous product ID : WZ9990.3212F

[Grub screw M10x1x11](#)

Product ID : 10165359
Previous product ID : 326057
