

## Drilling tool holder D32

### Technical data

Drive	not live
Fixation MS	Clamping ring D51
Cooling	internal
Pressure	80 bar
Mounting	D32
X [mm]	-
Y [mm]	-
Z [mm]	-
INDEX TRAUB products	MS32C • MS52C • MS32-6.2 • MS40-6 • MS40-8 • MS52-6.3 • MS32-6.3

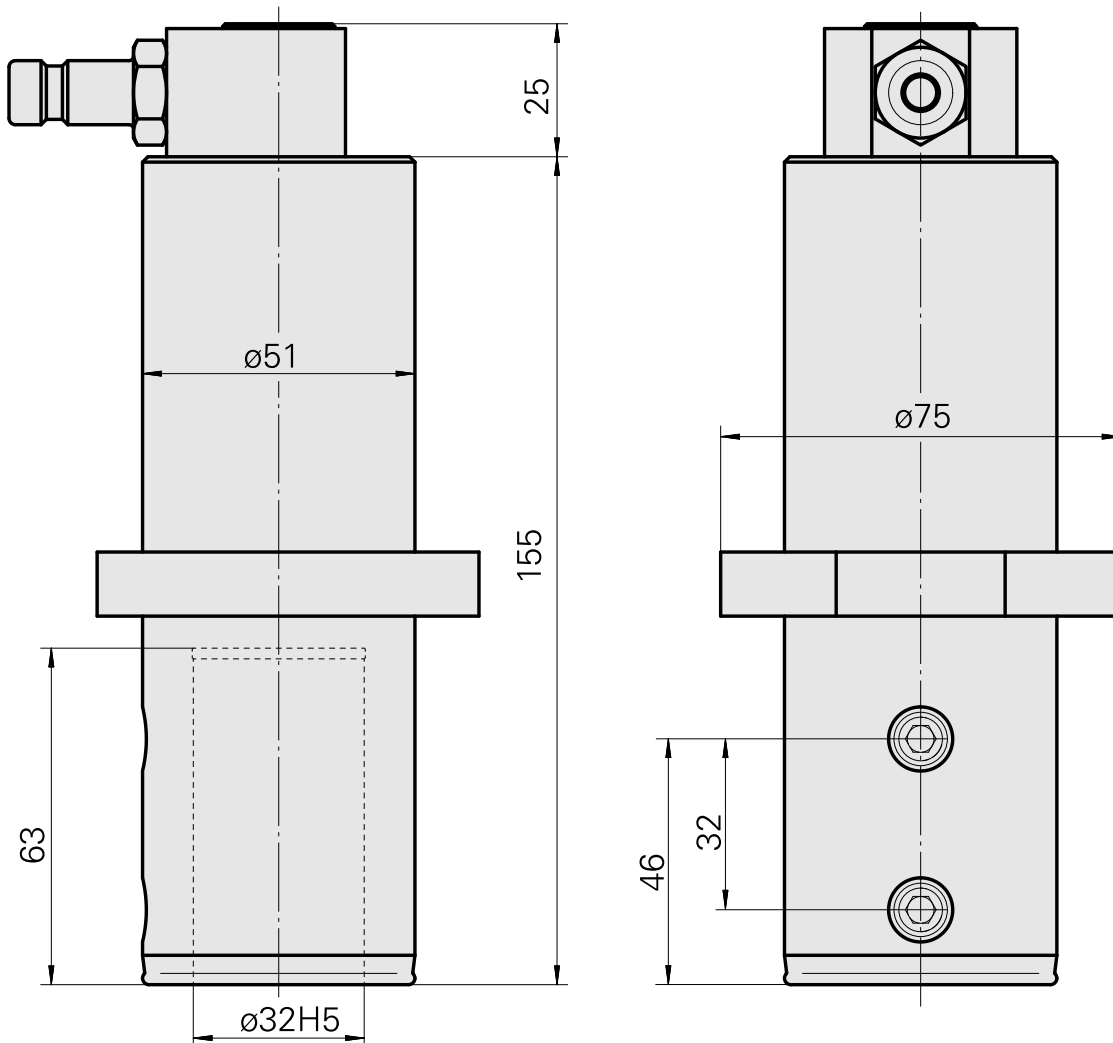
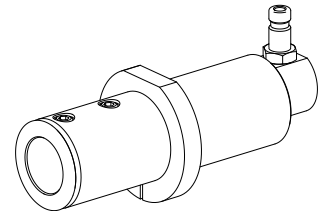

## Documents

No downloads available for this product

## Accessories

Optional accessories

### Other accessories

#### [Mounting sleeve with collar D32](#)

Product ID : 10505810

Previous product ID : W63221.40--

---

#### [QUICK COUPLING SP-006-0-WR513-11-2 Serie LP](#)

Product ID : 10837142

Previous product ID : 474940.0112

---

#### [QUICK DISCONNECT FITTING SP-006-1-WR013-11 Serie LP](#)

Product ID : 10186287

Previous product ID : 474946.25

---