

## Turning tool holder HSK 40 T square 20x2

### Technical data

<b>Shank HSK</b>	HSK 40
<b>Form HSK</b>	T
<b>Mounting</b>	Square 20x20
<b>Cooling</b>	external
<b>Pressure</b>	50 bar
<b>X [mm]</b>	75 (2.95")
<b>Z [mm]</b>	30 (1.18)
<b>INDEX TRAUB products</b>	G220.3 • G220 • R200 • TNX220.3

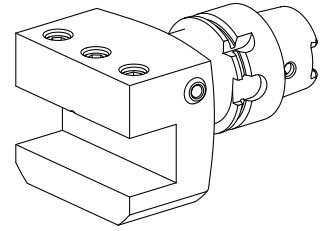

### Note

Not suitable for INDEX G160, G250 and G400! Adjacent stations in the tool magazine can only be used to a limited extent!

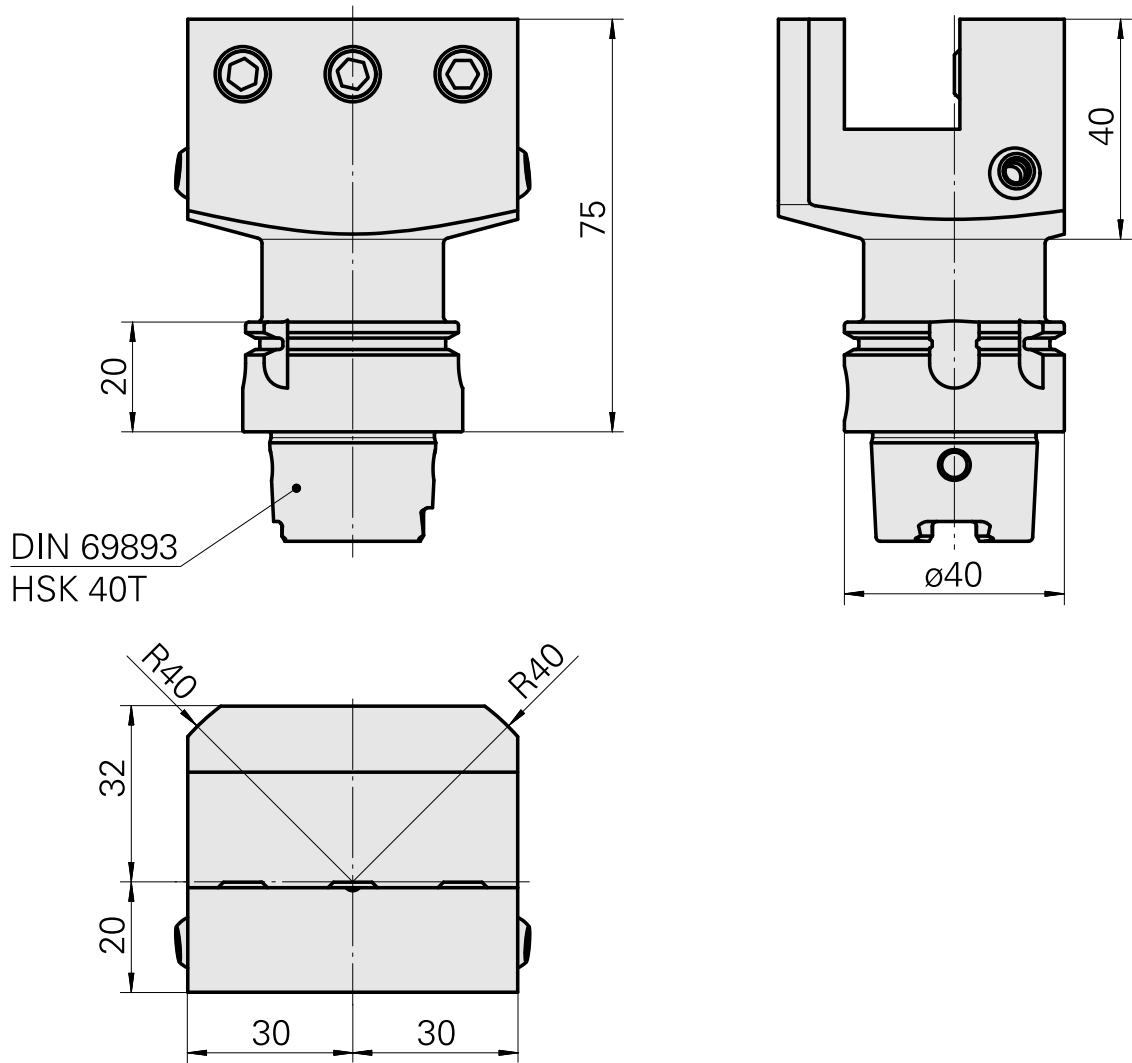

## Documents

No downloads available for this product

## Accessories

Required for operation

### [Socket wrench](#)

Product ID : 10532354

Previous product ID : WS7400.0010

TH accessories  
category  
Tool for KSS adapter

Mounting  
HSK 40 A/C

Optional accessories

### **Tool holder accessories**

### [Coolant adapter kit](#)

Product ID : 10581780

Previous product ID : WS7400.0020

TH accessories  
category  
Cooling lubricant  
transfer set

Mounting  
HSK 40 A/C

### [Coolant supply, max. 120 bar](#)

Product ID : 12024083

Previous product ID :

TH accessories  
category  
Cooling lubricant  
transfer set

Mounting  
HSK 40 A/C

---

[Angle, height 8 mm \(0.31"\), width 8 mm \(0.31"\)](#)

Product ID : 10271441

Previous product ID : W63300.0010

TH accessories  
category  
Compensation bracket

Mounting  
Square 20x20

[Angle, Height 4 mm, Width 4 mm](#)

Product ID : 10135472

Previous product ID : W63300.0020

TH accessories  
category  
Compensation bracket

Mounting  
Square 20x20