

Pinze ER per maschio filettare ET 1-32 7

Caratteristiche tecniche

Categoria acces. portautensile	Pinze ER per maschio filettare
Attacco	ER32
Attacco per utensile	7mm
Tipo pinza di serraggio	ET 1-32

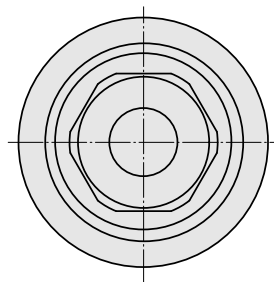
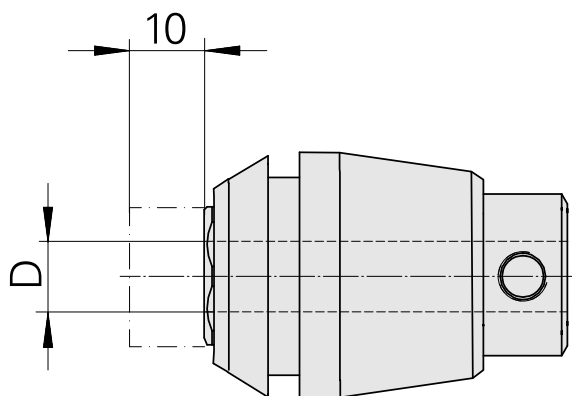
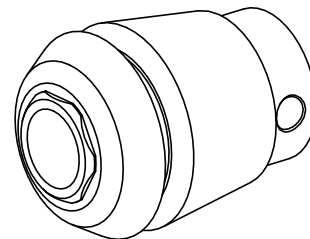

10606784
324257

INDEX

Documenti

Non sono disponibili download per questo prodotto