

## Plate, height 4 mm (0.15")

### Technical data

TH accessories category

Compensation plate

Mounting

Square 20x20

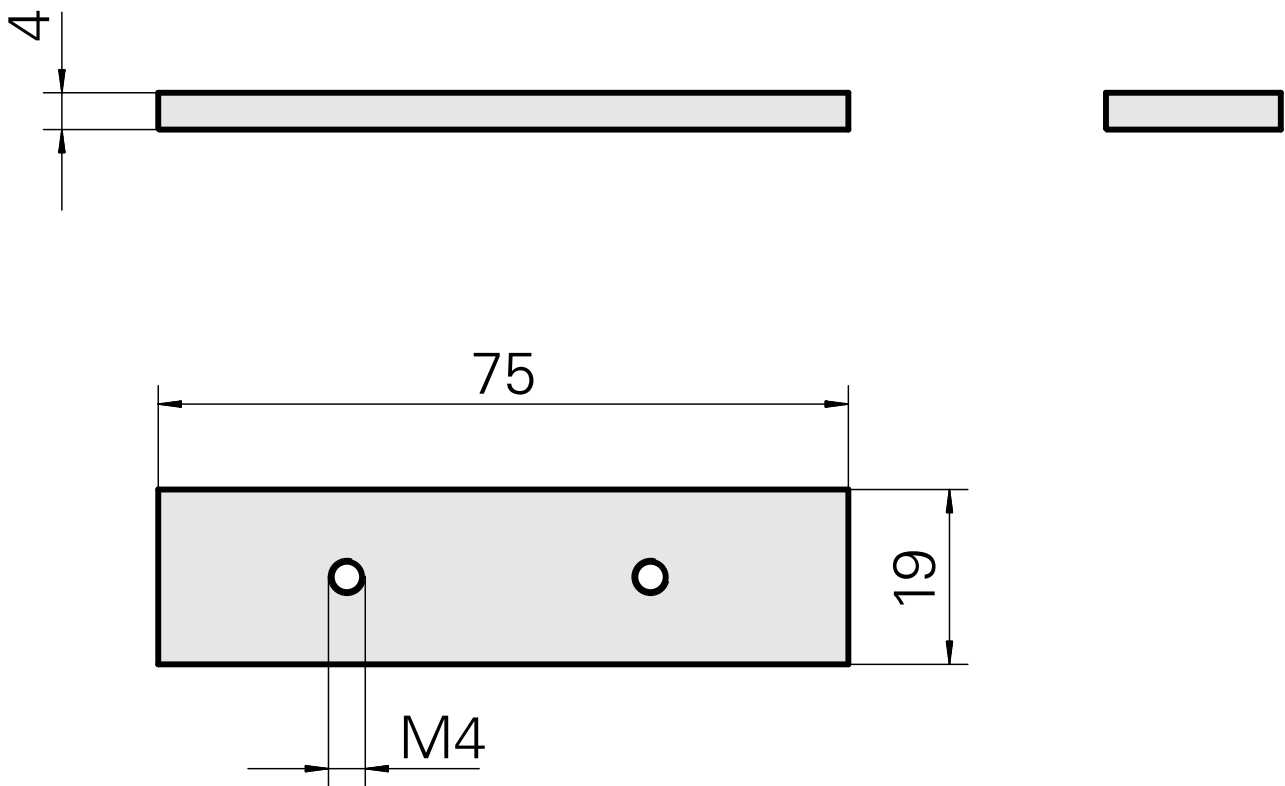
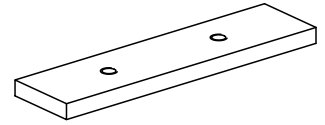

## **Documents**

No downloads available for this product