

## WFB 32-20 D4

### Caratteristiche tecniche

Categoria acces. portautensile	WFB 32-20
Attacco	D4
Accessorio per cambio rapido	attacco Weldon

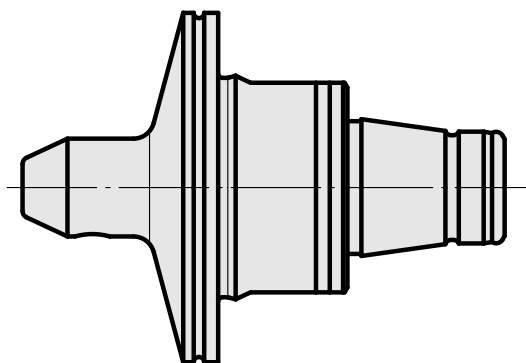
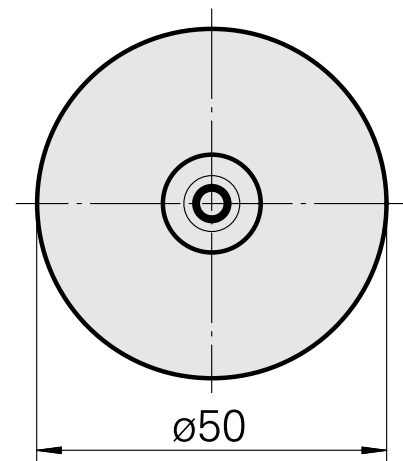
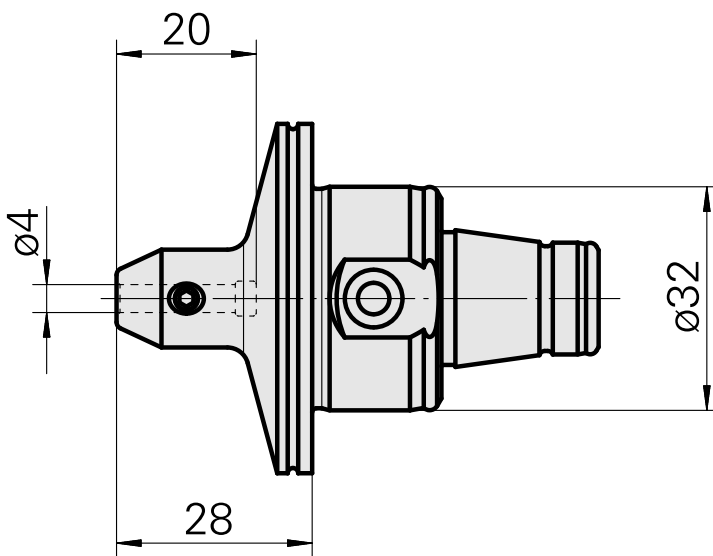
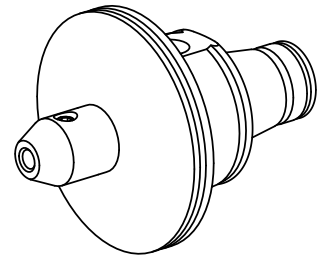

## **Documenti**

Non sono disponibili download per questo prodotto