

Portapunte Gambo 40 ER16

Caratteristiche tecniche

Gambo TNL	Gambo 40
Azionamento	non azionato
Raffreddamento	interno
Pressione	120 bar
Attacco	ER16
Prodotti INDEX TRAUB	TNK36 • TNL26

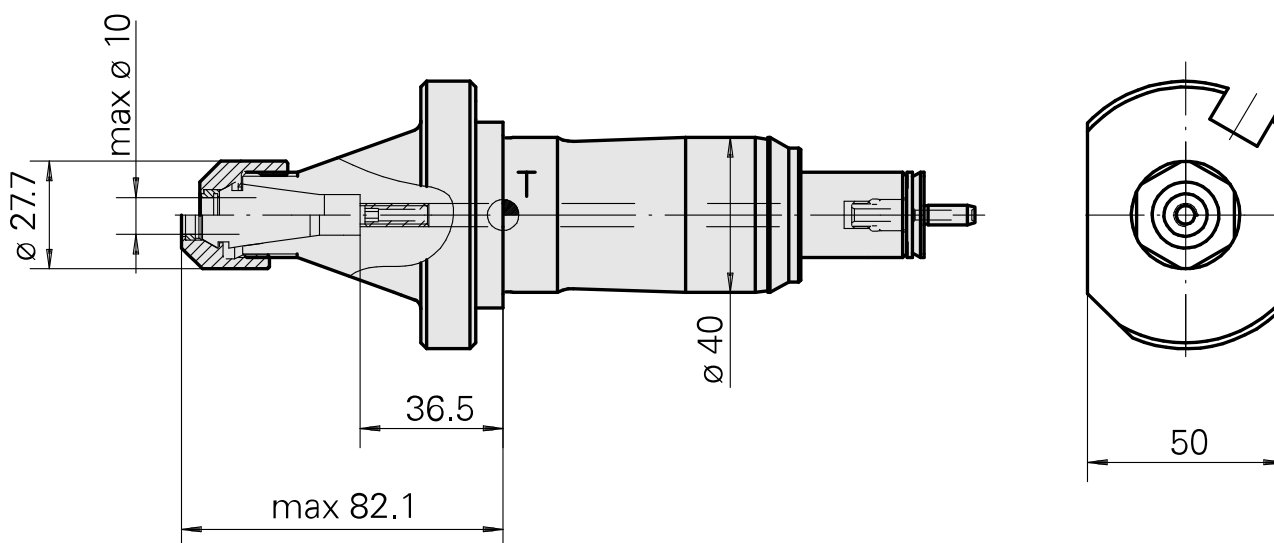
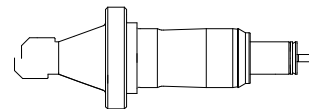

Documenti

Non sono disponibili download per questo prodotto

Accessori

Necessario per l'esercizio

[Chiave](#)

Id prodotto : 10966369

Id prodotto precedente : 490219.0161

Categoria acces. portautensile Attrezzo per pinze di serrag.	Attacco ER16	Tipo pinza di serraggio ER 16	Tipo dado di serraggio Filettatura interna
Strumento per pinze Chiave dado di serraggio			

Accessori opzionali

Tool holder accessories

[Dado di serraggio, per alimentazione interna lubrorefrigerante](#)

Id prodotto : 11065621

Id prodotto precedente : 901939.3161

Categoria acces. portautensile Dado di serraggio	Attacco ER16	Tipo pinza di serraggio ER 16	Tipo dado di serraggio Filettatura interna
--	-----------------	----------------------------------	---

Altri accessori

[Pinza di serraggio](#)

Id prodotto : 10589709

Id prodotto precedente : W99903--

[Pinza di serraggio](#)

Id prodotto : 10834596

Id prodotto precedente : 901930.1---

Pinza foratura filettata

Id prodotto : 10865233

Id prodotto precedente : WZ9990.9506F

Pinza foratura filettata ET-1-16

Id prodotto : 10542491

Id prodotto precedente : 3230--

Pinza di serraggio retrattile

Id prodotto : 10870393

Id prodotto precedente : W999065-

Pinza di serraggio, sigillato

Id prodotto : 10433061

Id prodotto precedente : W999083-

Disco di tenuta

Id prodotto : 10324863

Id prodotto precedente : W999036-
