

## Grooving tool holding block Trapezoid 32, vertically adjustable

### Technical data

Drive	not live
Cooling	external and internal
Pressure	20 bar
Mounting	Trapezoid 32x5
X [mm]	45 (1.77")
Y [mm]	–
Z [mm]	32 (1.26)
INDEX TRAUB products	C100 • TNX65/42

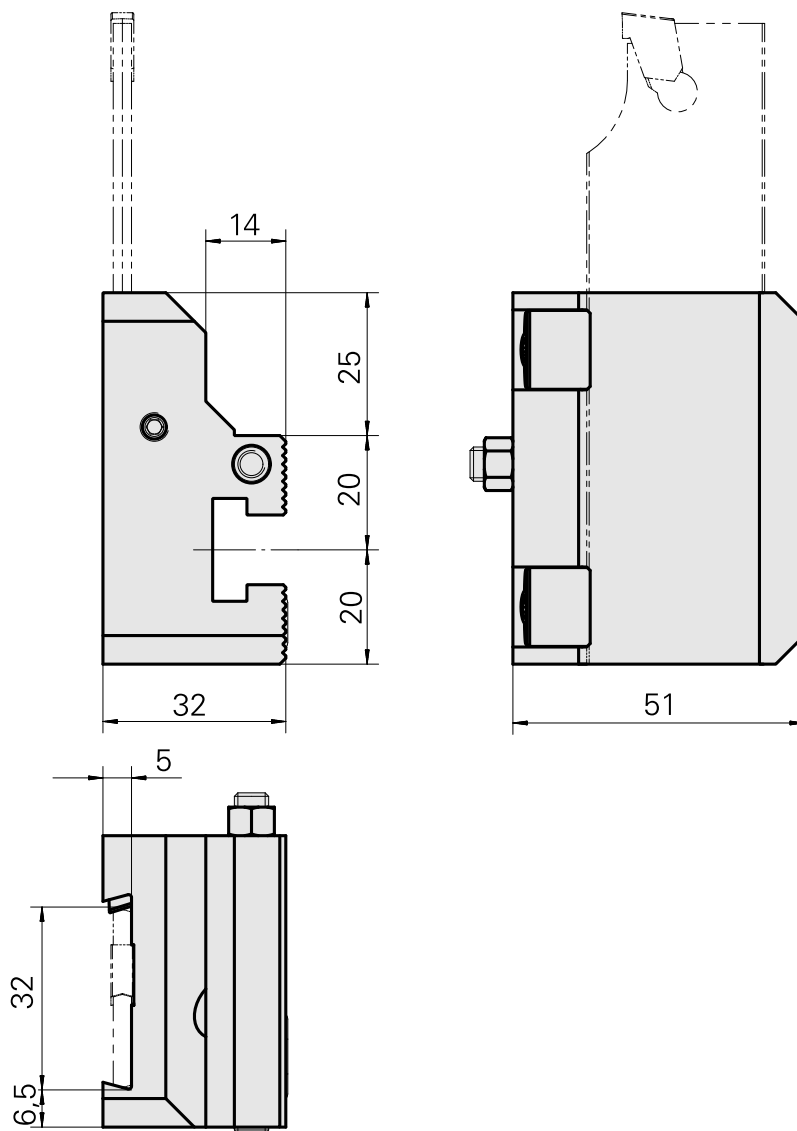
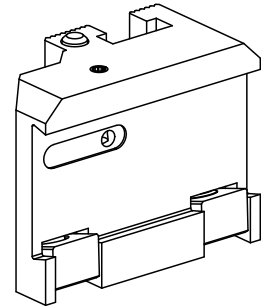

## **Documents**

No downloads available for this product