

Saw blade, circular saw blade width 4 mm (0.15")

Technical data

TH accessories category

Circular saw blade d125

Tool mounting

22mm

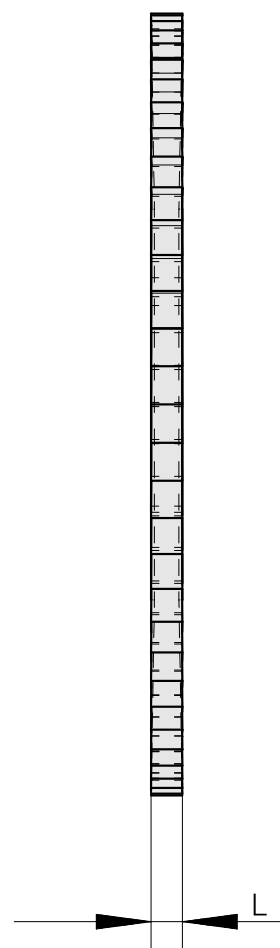
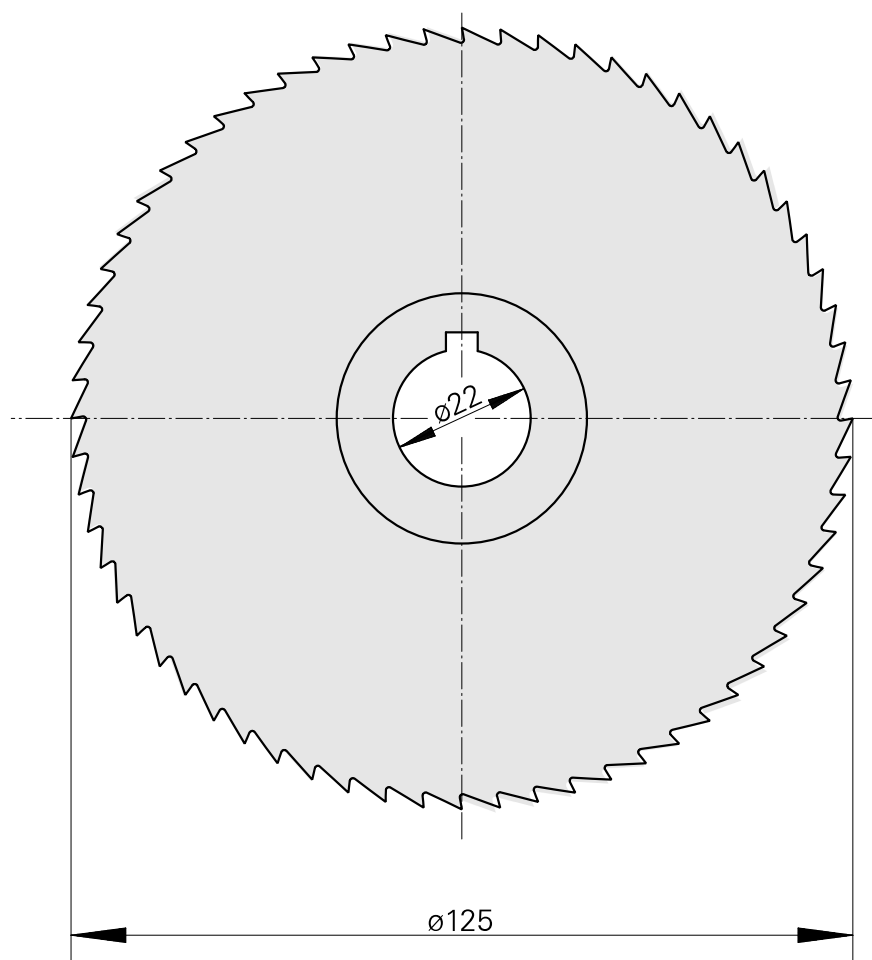

10306434
223015.2540

INDEX

Documents

No downloads available for this product