

## Drilling tool holder Shank 40 ER16

### Technical data

Shank TNL	Shank 40
Drive	not live
Cooling	internal
Pressure	120 bar
Mounting	ER16
INDEX TRAUB products	TNK36 • TNL26

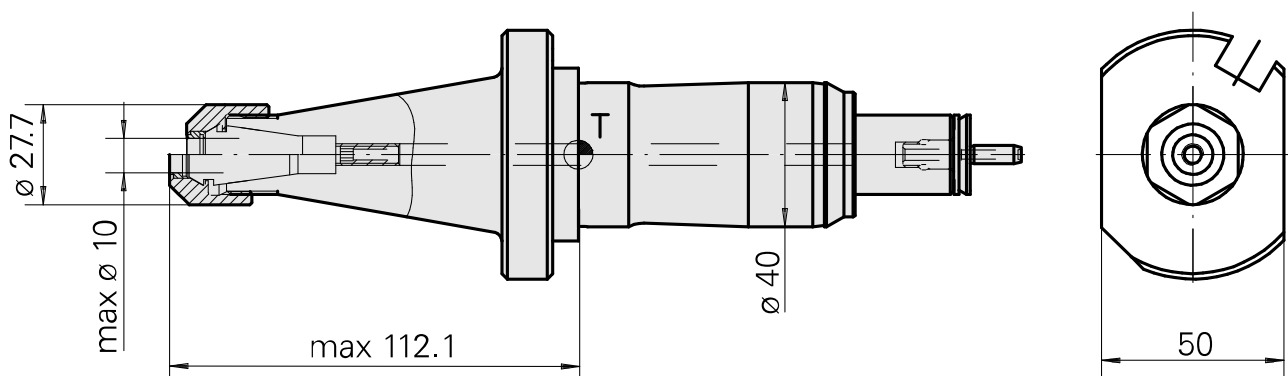
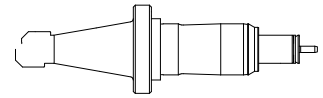

---

## Documents

No downloads available for this product

## Accessories

Required for operation

### [Spanner](#)

Product ID : 10966369

Previous product ID : 490219.0161

TH accessories category Tool	Mounting ER16	Collet type ER 16	Clamping nut type Female thread
Tools for Collet chucks Clamping nut wrench			

### Optional accessories

#### Tool holder accessories

### [Clamping nut, for internal cooling lubricant supply](#)

Product ID : 11065621

Previous product ID : 901939.3161

TH accessories category Clamping nut	Mounting ER16	Collet type ER 16	Clamping nut type Female thread
---	------------------	----------------------	------------------------------------

#### Other accessories

### [Clamping collet](#)

Product ID : 10589709

Previous product ID : W99903--

---

### [Clamping collet](#)

Product ID : 10834596

Previous product ID : 901930.1---

---

10170726  
986944

**INDEX**

---

[tapping tool collet](#)

Product ID : 10865233  
Previous product ID : WZ9990.9506F

---

[tapping tool collet ET-1-16](#)

Product ID : 10542491  
Previous product ID : 3230--

---

[Collet chuck](#)

Product ID : 10870393  
Previous product ID : W999065-

---

[Clamping collet, sealed](#)

Product ID : 10433061  
Previous product ID : W999083-

---

[Sealing washer](#)

Product ID : 10324863  
Previous product ID : W999036-

---