

ER-Collet chuck for taps ET 1-20 4.5mm

Technical data

TH accessories category	ER-Collet chuck for taps
Mounting	ER20
Tool mounting	4.5mm
Collet type	ET 1-20

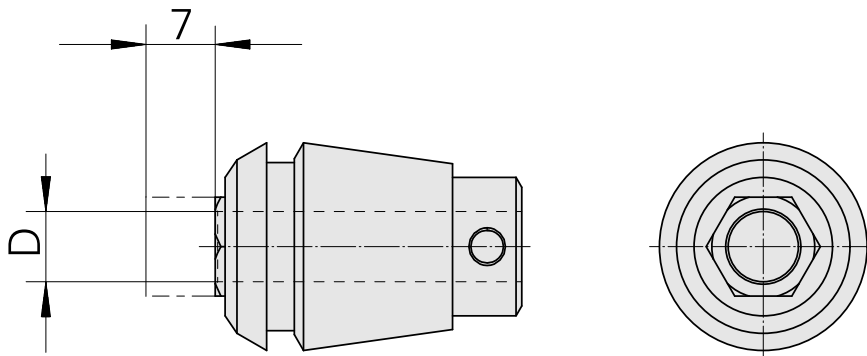
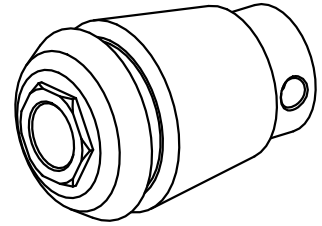

10161131
323445

INDEX

Documents

No downloads available for this product