

ER-Collet chuck for taps ET 1-32 5.6mm

Technical data

TH accessories category	ER-Collet chuck for taps
Mounting	ER32
Tool mounting	5.6mm
Collet type	ET 1-32

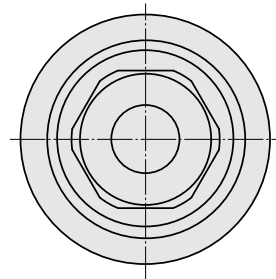
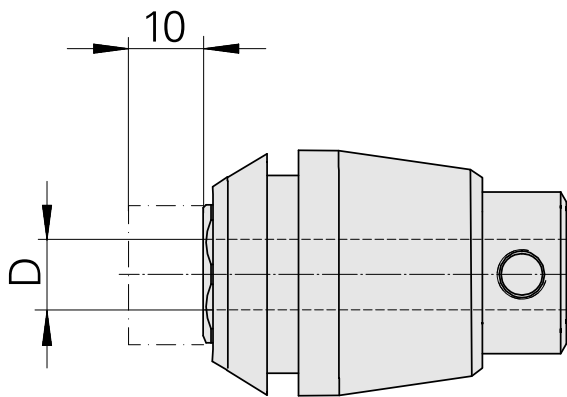

10132915
324254

INDEX

Documents

No downloads available for this product