

## 钻头刀架 刀柄 40 D16

### 技术特点

刀柄TNL	刀柄 40
驱动装置	非动力式
冷却	内冷
压力	120 bar
夹具	D16
INDEX TRAUB产品	TNK36 · TNL26

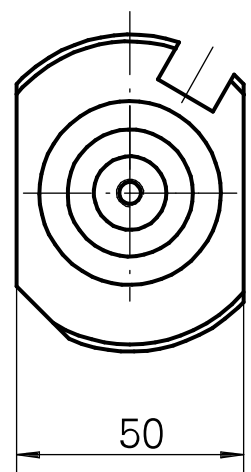
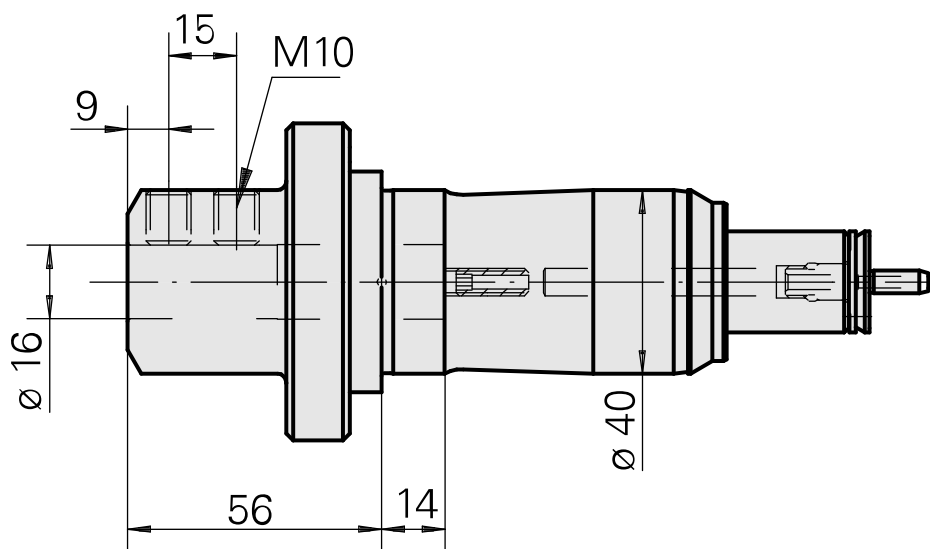
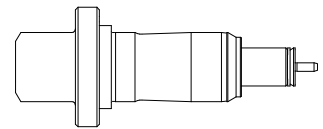

## 文件

没有针对此产品的任何下载