

WFB 32-20 D6

Données techniques

TH accessories category

WFB 32-20

Mounting

D6

Quick change inserts

Weldon mounting

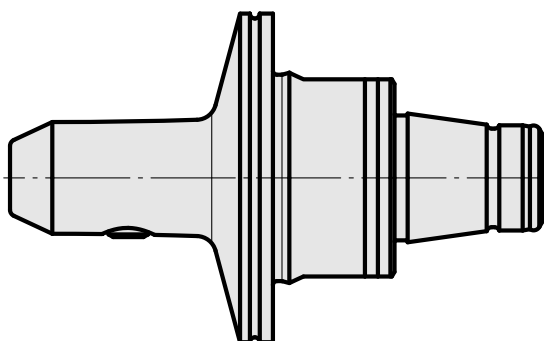
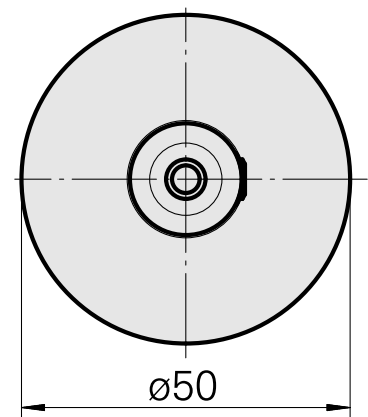
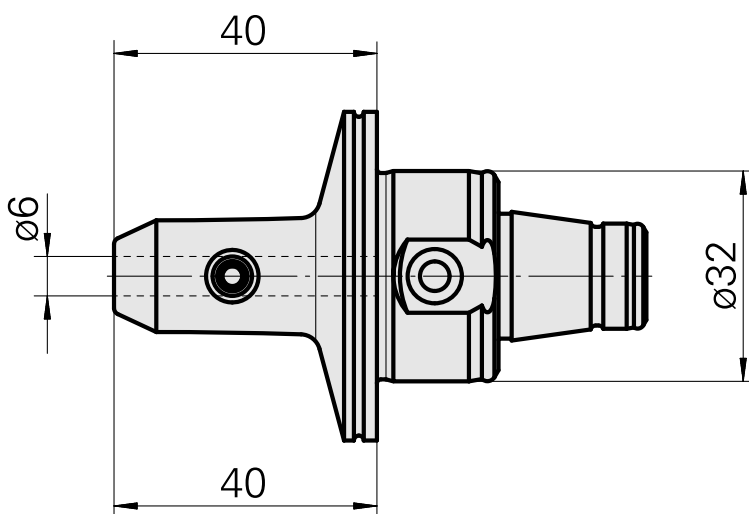
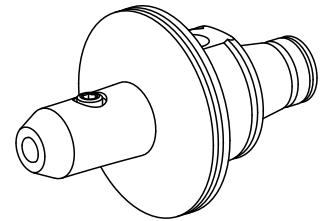

Documents

Aucun téléchargement n'est disponible pour ce produit