

ER-Collet chuck for taps ET 1-12 2.8mm

Données techniques

| | |
|----------------------------|-----------------------|
| Catégorie d'accessoires PO | Pince ER pour tarauds |
| Attachement | ER11 |
| Logement d'outils | 2,8mm |
| Type de pince de bridage | ET 1-12 |

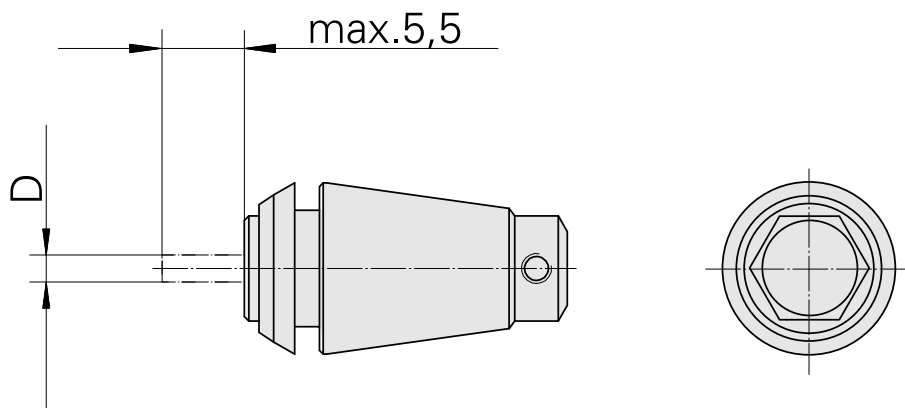
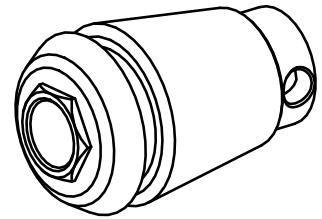

Documents

Aucun téléchargement n'est disponible pour ce produit