

Ausdrehkopf

Technische Daten

Aufnahme	für DN.. 1506..
Kühlung	innen
Druck	50 bar
X [mm]	36
Z [mm]	35
Produkte INDEX TRAUB	G220 • G420 • G520 • G320.2 • G220.3 • TNX220.3

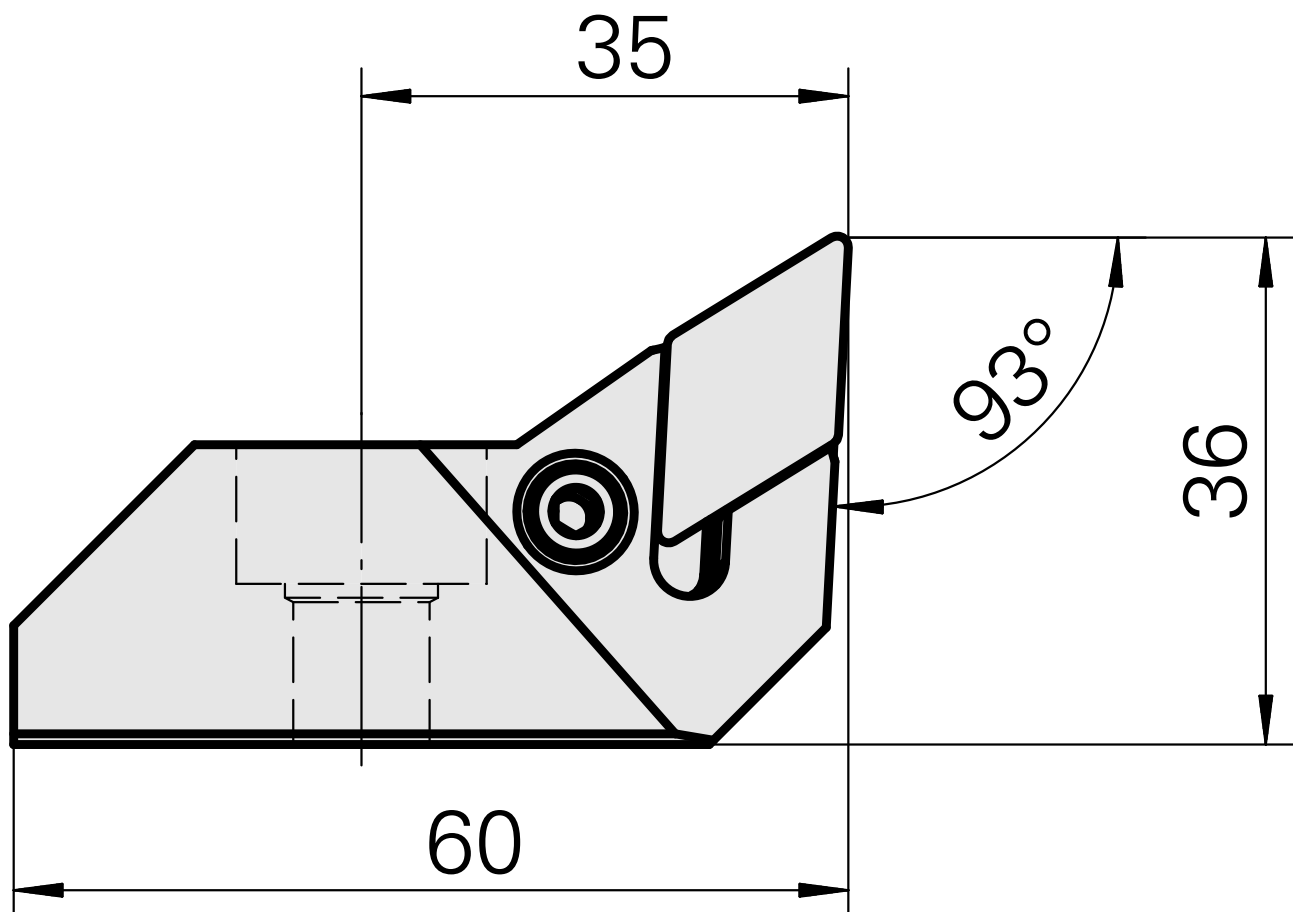
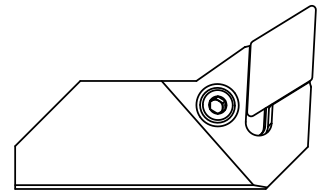

Dokumente

Für dieses Produkt sind keine Downloads vorhanden