

Clamping head Top40 D=31,00mm

Technical data

Clamping device size	SK40
manufacturer product line	TOPlus chuck
Clamping type	smooth
Nominal diameter (mm)	31 Millimeter
Clamping method	External clamping
manufacturer product line	Hainbuch

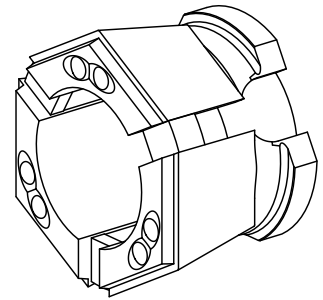

No 3-side view is currently available for this product

Documents

No downloads available for this product