

Saw blade, circular saw blade width 0.3 mm (0.011")

Technical data

TH accessories category

Circular saw blade d50

Tool mounting

13mm

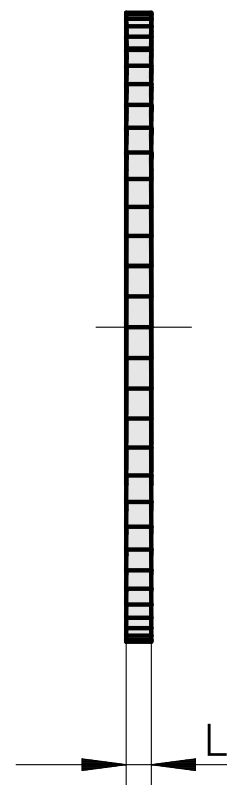
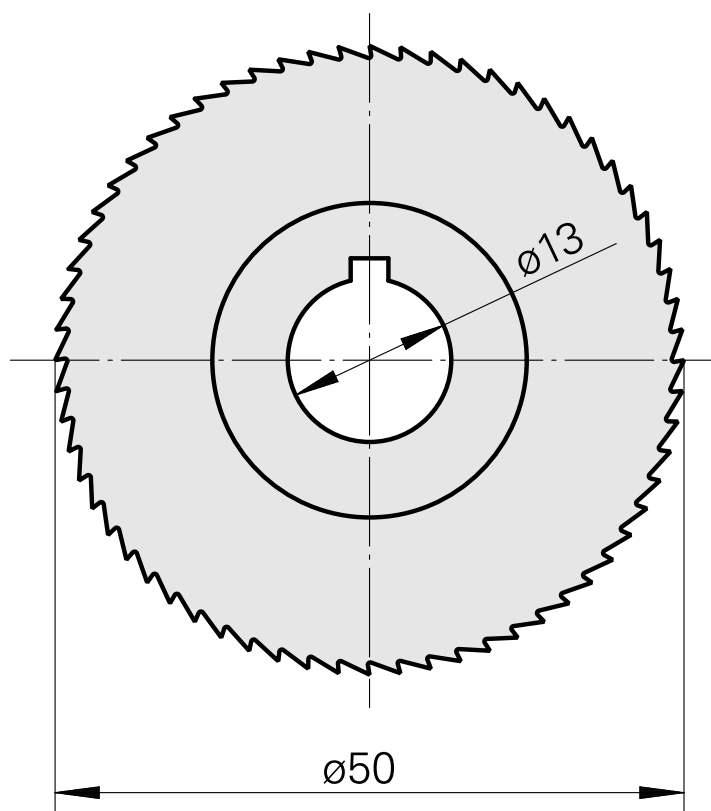
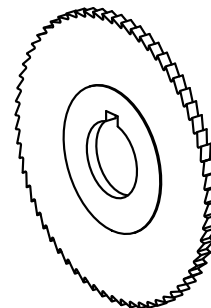

11053739
223010.5003

INDEX

Documents

No downloads available for this product