

Drilling tool holder ER25

Technical data

Drive	not live
Fixation MS	Clamping ring D51
Cooling	internal
Pressure	80 bar
Mounting	ER25
X [mm]	-
Y [mm]	-
Z [mm]	-
INDEX TRAUB products	MS32C • MS52C • MS32-6.2 • MS40-6 • MS40-8 • MS52-6.3 • MS32-6.3

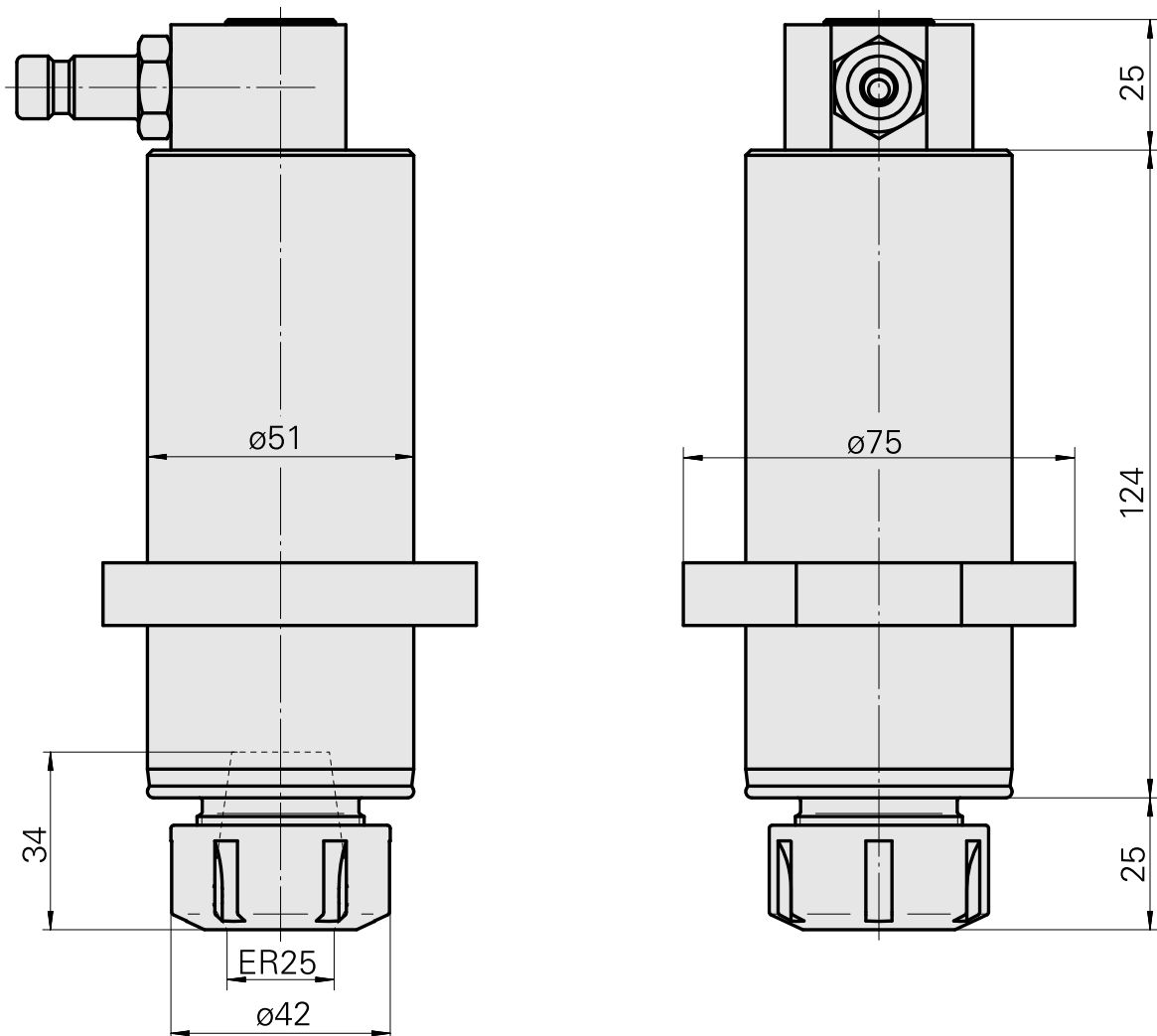
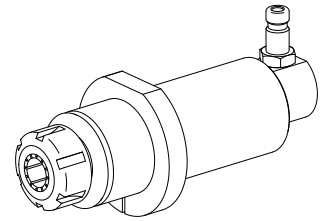

Documents

No downloads available for this product

Accessories

Required for operation

[Spanner](#)

Product ID : 10802433

Previous product ID : 490219.0251

TH accessories category Tool	Mounting ER25	Collet type ER 25	Clamping nut type Female thread
Tools for Collet chucks Clamping nut wrench			

Optional accessories

Tool holder accessories

[Clamping nut](#)

Product ID : 10193990

Previous product ID : 901939.0251

TH accessories category Clamping nut	Mounting ER25	Collet type ER 25	Clamping nut type Female thread
---	------------------	----------------------	------------------------------------

Other accessories

[Clamping collet](#)

Product ID : 10206464

Previous product ID : 901930.3---

[tapping tool collet ET-1-25](#)

Product ID : 10191234

Previous product ID : 3224--

[tapping tool collet](#)

Product ID : 10256515
Previous product ID : WZ9990.9507F

[Collet chuck](#)

Product ID : 10029756
Previous product ID : W999067-

[QUICK COUPLING SP-006-0-WR513-11-2 Serie LP](#)

Product ID : 10837142
Previous product ID : 474940.0112

[QUICK DISCONNECT FITTING SP-006-1-WR013-11 Serie LP](#)

Product ID : 10186287
Previous product ID : 474946.25
