

WFB 32-20 D8

Caratteristiche tecniche

Categoria acces. portautensile	WFB 32-20
Attacco	D8
Accessorio per cambio rapido	attacco Weldon

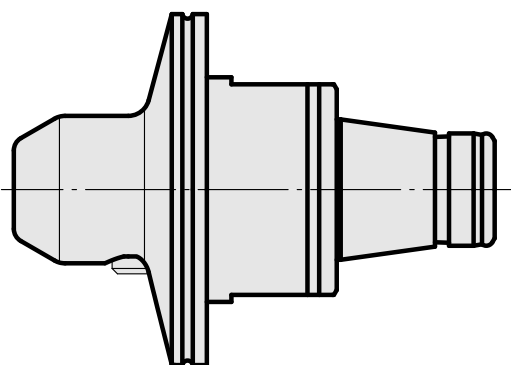
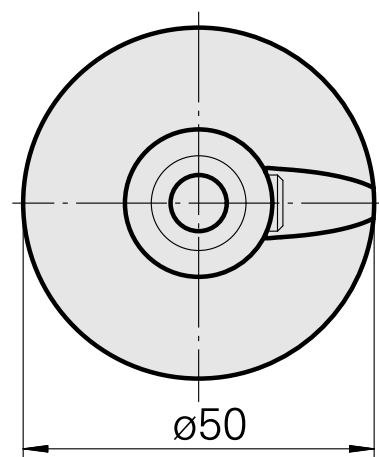
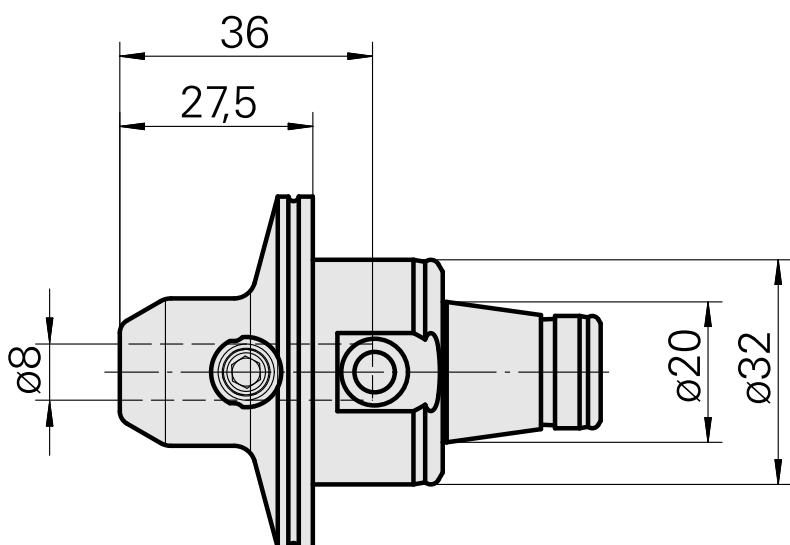
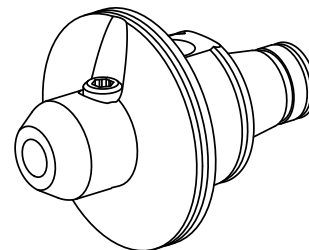

Documenti

Non sono disponibili download per questo prodotto