

Turning tool holder VDI 20 square 3/4"x3, Form C2/C3

Technical data

Shank VDI	VDI 20
Drive	not live
Fixation VDI	W serration
Cooling	external
Pressure	20 bar
Mounting	Square 3/4"x3/4"
reversible 180°	yes
X [mm]	55 (2.17")
Y [mm]	—
Z [mm]	35 (1.38)
INDEX TRAUB products	C100

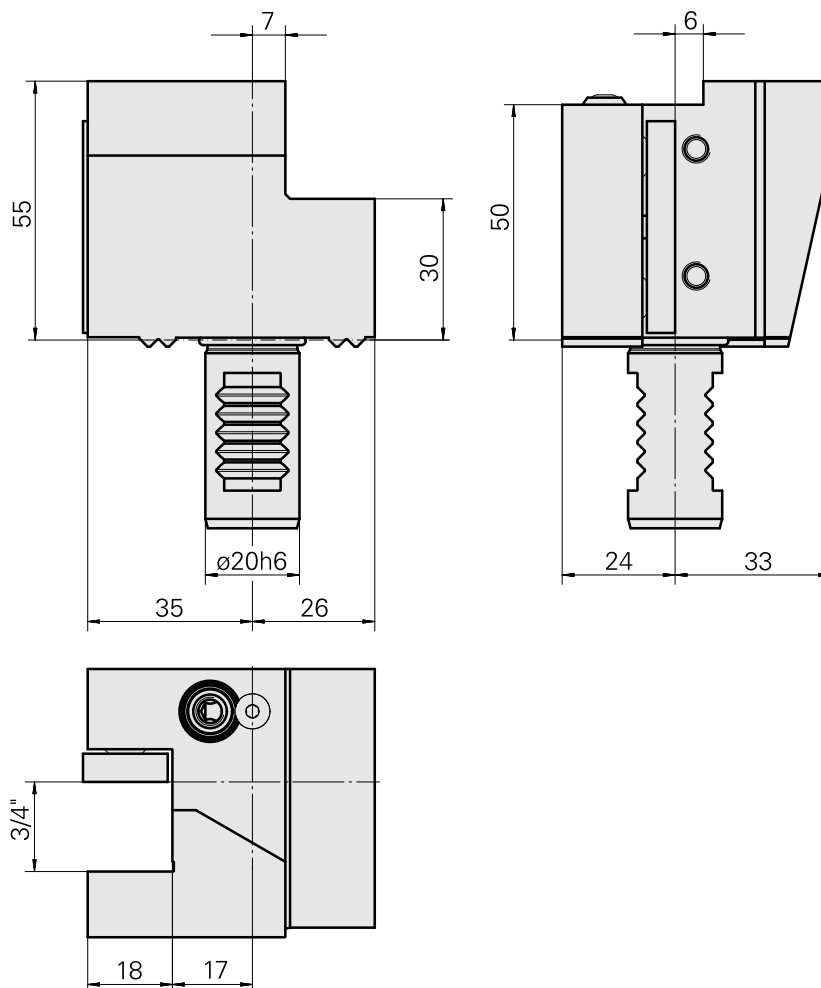
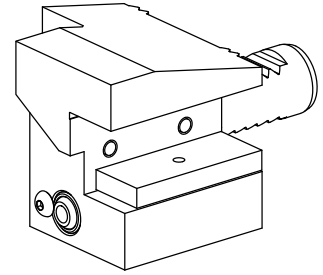

Documents

No downloads available for this product

Accessories

Optional accessories

Other accessories

[Seal](#)

Product ID : 10478680

Previous product ID : W67221.4196

[Blanking plug D12](#)

Product ID : 10532667

Previous product ID : W00015.0021

[BALL SPRAY NOZZLE 12D/M6](#)

Product ID : 10602750

Previous product ID : 474550.0101

[Lens head screw](#)

Product ID : 10344546

Previous product ID : 410243.0406
