

Saw blade, circular saw blade width 1.6 mm (0.06")

Technical features

TH accessories category

Circular saw blade d63

Tool mounting

16 mm

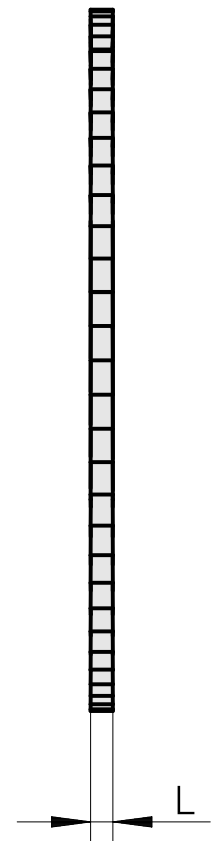
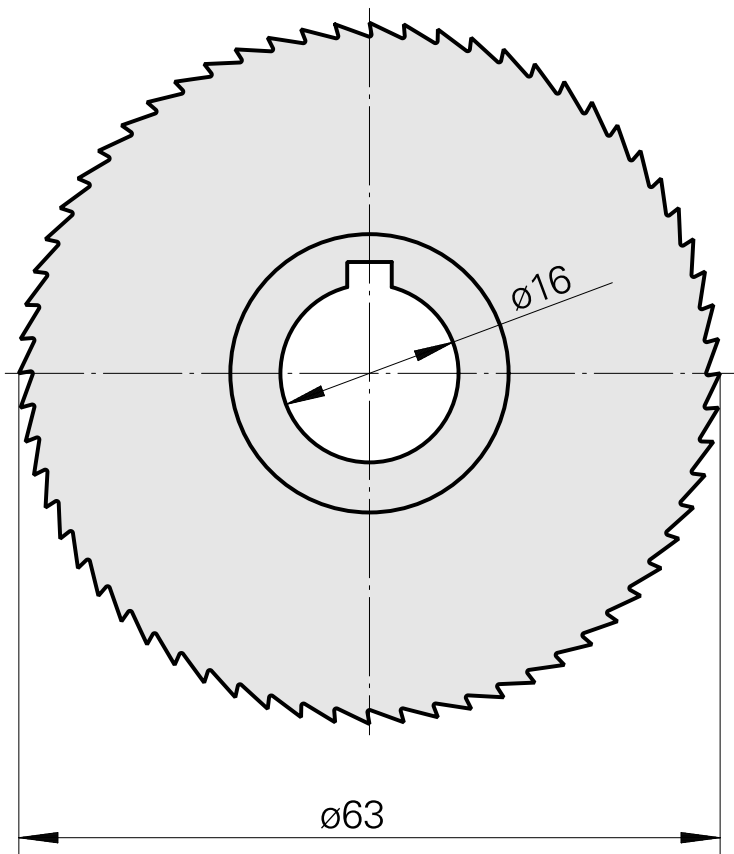
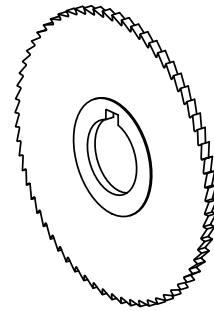

10725710
223010.6316

INDEX

Documents

No downloads available for this product