

Spannmutter M18x1 Hi-Q/ERAX11

Technische Daten

WZH Zubehörkategorie	Spannmutter
Aufnahme	ER11
Spannzangentyp	ER11
Spannmuttertyp	Außengewinde

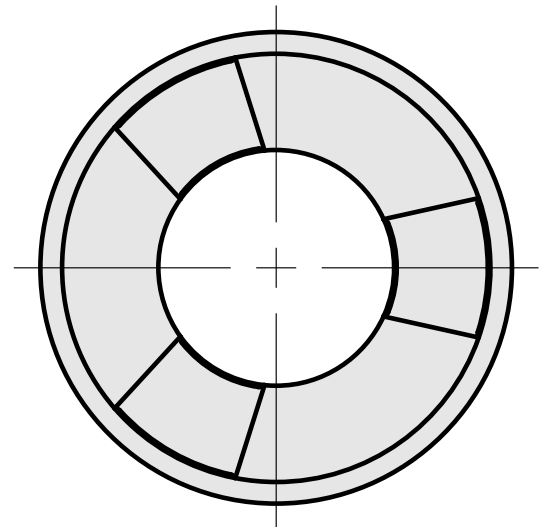
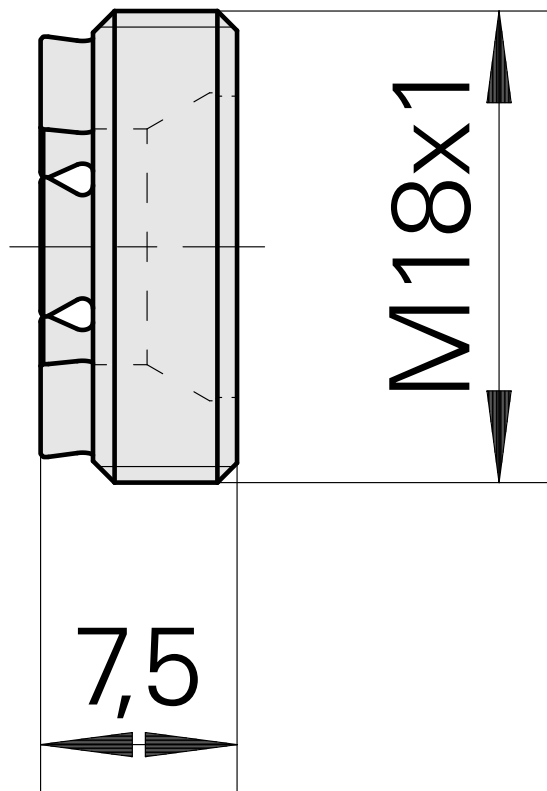
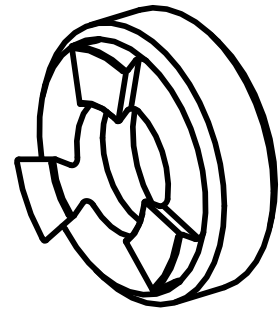

Dokumente

Für dieses Produkt sind keine Downloads vorhanden