

## Saw blade, circular saw blade width 1.6 mm (0.06")

### Technical data

TH accessories category

Circular saw blade d80

Tool mounting

16mm

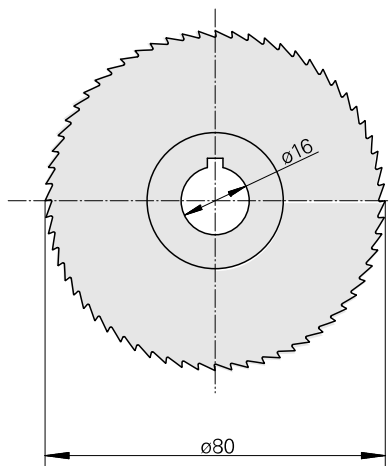

10380724  
223011.8016

**INDEX**

---

## **Documents**

No downloads available for this product