

## WFB 20-12 Hydraulic expansion chuck D6

### Technical data

TH accessories category

WFB 20-12

Mounting

Hydraulic expansion chuck D6

Quick change inserts

hydraulic expan. mounting

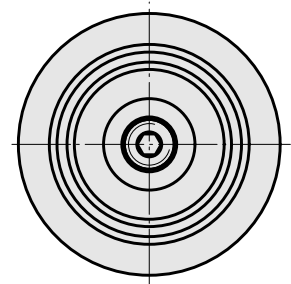
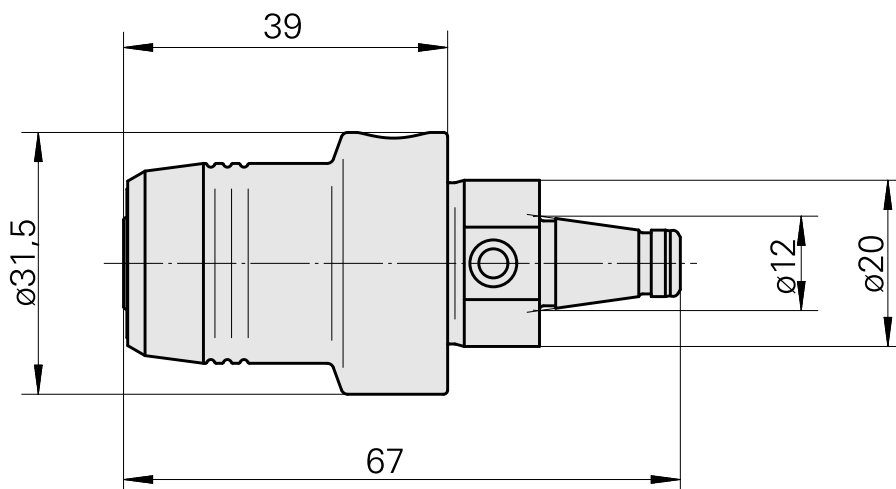

## **Documents**

### **Product notes**

[DE \(pdf\)](#)

[EN \(pdf\)](#)

[FR \(pdf\)](#)