

Drilling tool holder Shank 40 D25 (0.98)

Technical data

Shank TNL	Shank 40
Drive	not live
Cooling	internal
Pressure	120 bar
Mounting	D25
INDEX TRAUB products	TNK36 • TNL26

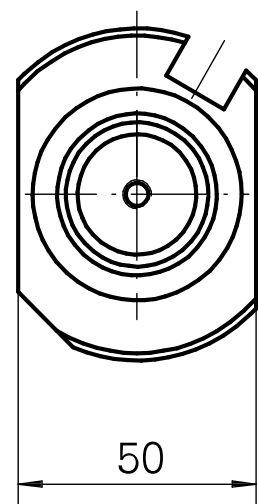
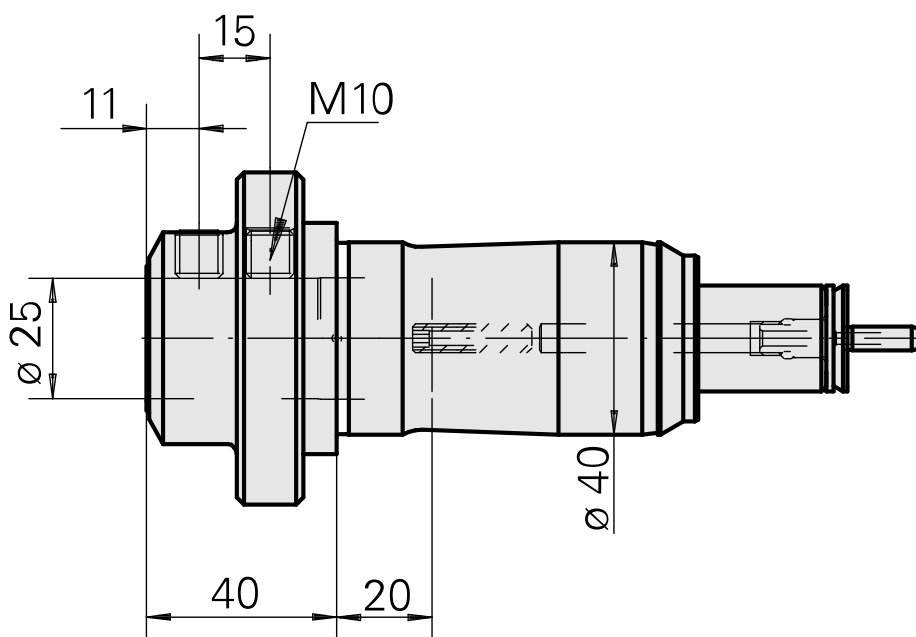
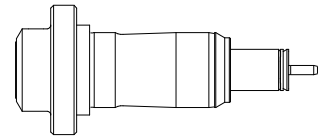

10334219
835045

INDEX

Documents

No downloads available for this product