

## Bohrhalter HSK 25 C DIN 1835 B/E D8

### Technische Daten

Schaft HSK	HSK 25
Form HSK	C
Aufnahme	DIN 1835 B/E D8
Kühlung	innen
Druck	40 bar
X [mm]	42
Produkte INDEX TRAUB	MS22-6 • MS22-8 • MS16-6

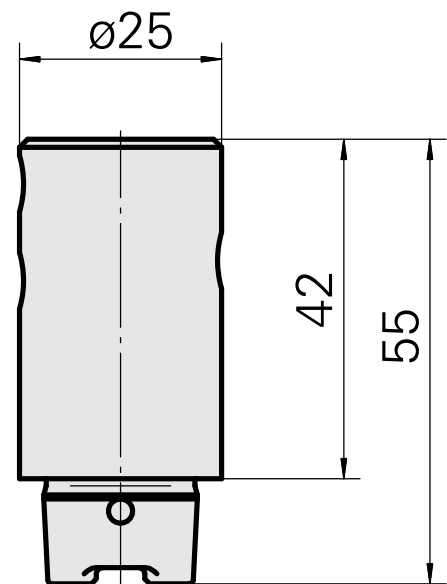
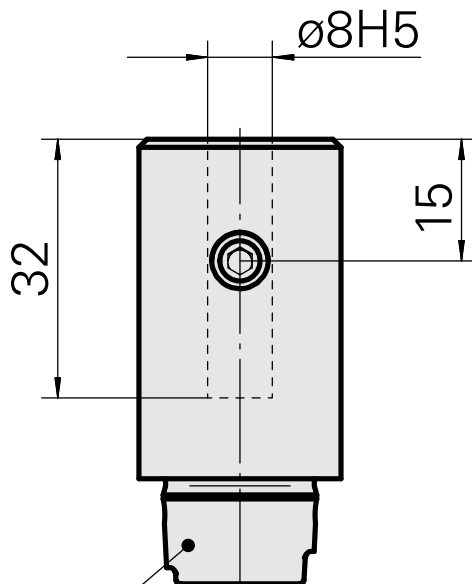
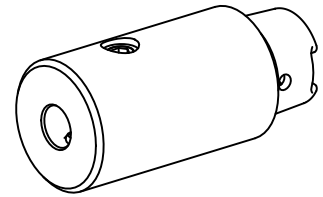

DIN 69893  
HSK 25 C

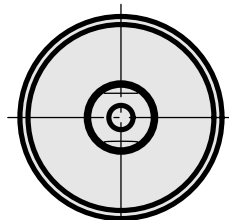

## **Dokumente**

Für dieses Produkt sind keine Downloads vorhanden