

## Saw blade, circular saw blade width 0.8 mm (0.031")

### Technical features

TH accessories category

Circular saw blade d63

Tool mounting

16 mm

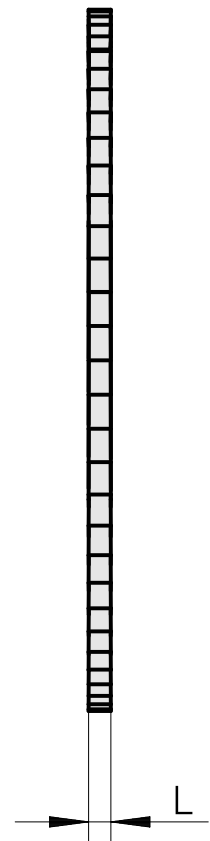
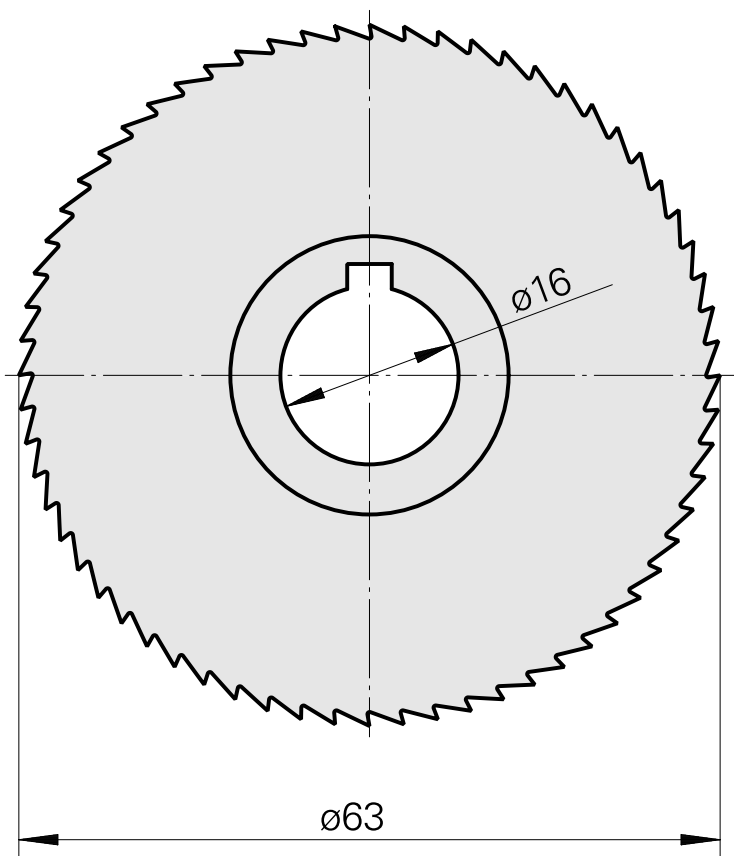
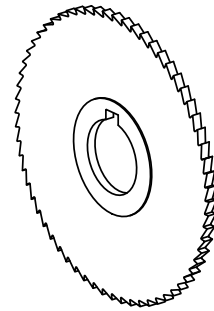

10083286  
223010.6308

**INDEX**

---

## **Documents**

No downloads available for this product